

Accessories & Assembly Instructions Index

Alphabetical Index

Part Number Index

DESCRIPTION	PAGES	PART #	PG.	PART #	PG.	PART #	PG.
Assembly Equipment		583	335	FF13273	299	FT1271	335
Crimp	327-331	624	296	FF13570	299	FT1279	340
Reusable	332-336	1561	335	FF13571	299	FT1281	333
Assembly Instructions	309-326	1562	335	FF90308	297	FT1283	329
Cut Off Equipment	337-339	1563	335	FF90311	297	FT1307	330
Proof Test Equipment	341-342	1582	335	FT1013	333	FT1312	341
Skiving Equipment	340	1597	335	FT1028	334	FT1355-01	296
		1598	335	FT1033	334	FT1330-XL	329
		1599	335	FT1038A	336	FT1380	327
		222005	295	FT1058	342	FT1380P	327
		222022	295	FT1081	336	FT1390	329
		900564	295	FT1090	336	FT1500	337
		900952	295	FT1092	329	HP	298
		900705	295	FT1095	335	HPM	298
		900729	297	FT1097	332	HSM	298
		F2015	336	FT1101	338	HLM	298
		FC425	296	FT1215	339	S1026	339
		FF9075	222, 310	FT1220	335	S1043	339
		FF9217	296	FT1229	340	S1102	339
		FF13267	299	FT1230	340	S1104	338
		FF13268	299	FT1234	334	S1118	339
		FF13269	299	FT1240	340	S1120	339
		FF13270	299	FT1258	337	SC1681	339
		FF13271	299	FT1260	338	SC1709	339
		FF13272	299	FT1261	341	SC1772	338

WARNING

The user must exercise extreme care when operating any Eaton assembly equipment with powered moving components. Safety glasses must be worn at all times when using any Eaton assembly equipment.

Read and understand the owners and operators manual before attempting to operate any equipment.

Eaton personnel are available to answer any questions, please call Eaton Corporation, 14615 Lone Oak Road, Eden Prairie, MN 55344, 952-937-9800.

Eaton assembly equipment is designed to be used only with Aeroquip hose and Eaton hose fittings.

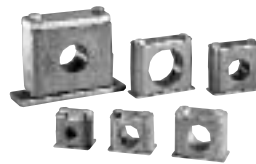

Protective coils, sleeves & clamps

222005*, 222022

Stainless steel internal support coils



Recommended for vacuum service with most hose.

For use with hose: see pages 300-308.

PART NUMBER	COIL O.D.	
	mm	in.
222005-23C	8,6	.34
222005-10C	10,7	.42
222005-21C	12,9	.51
222005-11C	15,2	.60
222022-12C	17,8	.70
222005-13C	18,5	.73
222005-14C	23,9	.94
222022-16C	24,6	.97
222005-15C	30,2	1.19
222022-20C	31,7	1.25
222005-17C	36,6	1.44
222022-24C	38,1	1.50
222005-18C	47,7	1.88
222022-32C	50,0	1.97
222005-19C	62,0	2.44
222022-40C	67,8	2.67
222022-48C	83,0	3.27
222022-60C	108,7	4.28
222022-80C	134,1	5.28

**222005 is 301 stainless steel.*

900705

Steel protective coil sleeve



Recommended for use where hose lines are subjected to excessive abrasion, kinking or accidental damage. Construction: spring steel, rust resistant.

This coil should fit snugly to the hose O.D. expanding the coil I.D. (unwind the coil) may be necessary for proper installation.

For use with hose: see pages 300-308.

SLEEVE DASH NO	SLEEVE I.D.	
	mm	in.
-17S	11,2	.44
-1S	12,7	.50
-13S	14,5	.57
-2S	16,0	.63
-3S	19,0	.75
-4S	22,3	.88
-5S	26,2	1.03
-14S	28,7	1.13
-6S	31,0	1.22
-7S	37,3	1.47
-9S	42,9	1.69
-8S	48,5	1.91
-10S	54,1	2.13
-16S	62,0	2.44
-11S	65,0	2.56

900564

Steel protective coil spring



Protects hose cover and reinforcement from abrasion and accidental damage. Construction: steel wire, rust resistant.

This coil should fit snugly to the hose O.D. expanding the coil I.D. (unwind the coil) may be necessary for proper installation.

For use with hose: see pages 300-308.

SLEEVE DASH NO	SLEEVE I.D.	
	mm	in.
-1S	15,5	.61
-12S	17,0	.67
-2S	19,0	.75
-15S	20,6	.81
-14S	21,6	.85
-3S	23,1	.91
-4S	26,4	1.04
-5S	30,0	1.18
-6S	34,0	1.34
-7S	42,2	1.66
-9S	47,5	1.87
-8S	54,1	2.13
-10S	60,4	2.38
-13S	69,8	2.75
-11S	73,1	2.88

900952

Plastic protective coil sleeve



Recommended to protect hose from abrasion, this light weight plastic sleeve is unaffected by air, water, oil, gasoline, hydraulic and most other fluids. This coil can also be used for group bundling of hose lines. Temperature range of 0°F to +180°F.

For use with hose: see pages 300-308.

PART NO	SLEEVE I.D.	
	mm	in.
900952-30	40,0	1.58
900952-22	34,0	1.34
900952-16	27,0	1.06
900952-12	21,0	.83
900952-10	16,0	.63
900952-8	12,5	.49
900952-6	9,5	.37
900952-4	6,0	.24

SPECIALTY & TRUCK HOSE

LOW & MEDIUM PRESSURE HOSE

HIGH PRESSURE HOSE

HOSE FITTINGS

ADAPTERS & TUBE FITTINGS

ACCESSORIES & ASSEMBLY INSTRUCTIONS

HOSE ASSEMBLY EQUIPMENT

APPENDICES

624

Firesleeve



Firesleeve will protect hose from direct flame. Firesleeve is constructed of a uniform single layer of braided fiberglass tubing impregnated with flame resistant silicone rubber. Temperature range of -65°F to +500°F.

For use with hose: see pages 300-308.

PART #	I.D.		CLAMP # (2 required)
	mm	in.	
624-5	7,9	.31	FF9217-0622S
624-7	11,2	.44	FF9217-0622S
624-8	12,7	.50	FF9217-0622S
624-9	14,2	.56	FF9217-0622S
624-10	15,7	.62	FF9217-0622S
624-11	17,5	.69	FF9217-0622S
624-12	19,0	.75	FF9217-0622S
624-13	20,6	.81	FF9217-0622S
624-14	22,3	.88	FF9217-0622S
624-16	25,4	1.00	FF9217-0622S
624-18	28,4	1.12	FF9217-0622S
624-20	31,7	1.25	FF9217-0648S
624-22	35,0	1.38	FF9217-0648S
624-24	38,1	1.50	FF9217-0648S
624-26	41,1	1.62	FF9217-0648S
624-28	44,4	1.75	FF9217-0648S
624-30	47,7	1.88	FF9217-0648S
624-32	50,8	2.00	FF9217-0648S
624-38	60,4	2.38	FF9217-0648S
624-42	66,5	2.62	FF9217-0648S
624-46	73,1	2.88	FF9217-0664C
624-50	79,2	3.12	FF9217-0664C
624-54	85,8	3.38	FF9217-0664C
624-60	95,2	3.75	FF9217-0664C

FC425

Nylon abrasion sleeve Meets MSHA requirements

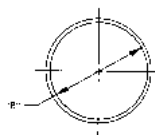

Nylon sleeve protects hose from abrasion and allows bundling of hose lines.

For use with hose: see pages 300-308.

PART #	NOMINAL SLEEVE I.D.* "B"	
	mm	in
FC425-12	18,0	.71
FC425-16	25,4	1.00
FC425-18	28,7	1.13
FC425-20	31,7	1.25
FC425-24	40,4	1.59
FC425-28	44,4	1.75
FC425-32	52,6	2.07
FC425-38	60,4	2.38
FC425-40	64,5	2.54
FC425-46	72,6	2.86
FC425-54	84,8	3.34
FC425-59	93,0	3.66

** The maximum O.D. of hose fittings must be allowed for if fittings are to be covered.*

FF9217 Firesleeve clamp



Recommended for attaching 624 Firesleeve to hose lines.

Clamp numbers: FF9217-0622S, FF9217-0648S; 3/8 inch wide, FF9217-0664C; 1/2 inch wide.

For use with hose: see pages 300-308.



Hose Cleaning System

The Jetcleaner™ hose cleaning system offers a revolutionary solution for the internal cleaning of bulk hose and finished hose assemblies. Using a low pressure air gun, the Jetcleaner system routes a foam projectile through the hose to thoroughly remove debris remaining from cutting, skiving and assembly operations. Available in kit form or as individual components, the Jetcleaner hose cleaning system is the system of choice for hose assembly professionals.

Hose Kit (P/N FT1355-01)

Includes:

Jetcleaner pistol, Hose nozzles, 1/4" through 2" ID, Adapter ring, Bench stand, Aluminum case, Quick disconnect coupling

Note: Hose projectiles (P/N FT1355-3-size) not included in kit.

Also available individually:

Jetcleaner pistol – FT1355-1-01

Hose nozzles – FT1355-2-size

Hose projectiles – FT1355-3-size

Coupling nozzles – FT1355-4-size

Coupling projectiles – FT1355-5-size

Adapter ring – FT1355-10-01

Carrying case – FT1355-11-02

Bench stand – FT1355-12-01

SPECIALTY & TRUCK HOSE
 LOW & MEDIUM PRESSURE HOSE
 HIGH PRESSURE HOSE
 HOSE FITTINGS
 ADAPTERS & TUBE FITTINGS
 ACCESSORIES & ASSEMBLY INSTRUCTIONS
 HOSE ASSEMBLY EQUIPMENT
 APPENDICES

900729

Support clamp



These lightweight vinyl-coated steel support clamps are designed to support hose where long runs are necessary.

This clamp not only furnishes a cleaner installation, but prevents damage, exposure and chafing.

The lining will withstand high ambient temperatures.

Bolt hole dia: Clamp dash no. -01 thru -8, -18 thru -23 is .406; -9 thru -17, -24 thru -31 is .531.

For use with hose: see pages 300-308.

CLAMP DASH NO.	CLAMP I.D. CLOSED	
	mm	in
-18	6,3	.25
-19	9,6	.38
-01	11,2	.44
-1	12,7	.50
-2	14,2	.56
-21	16,0	.63
-3	17,5	.69
-4	19,0	.75
-5	20,6	.81
-6	23,9	.94
-23	25,4	1.00
-8	26,9	1.06
-9	28,7	1.13
-27	30,2	1.19
-24	31,7	1.25
-25	33,3	1.31
-10	38,1	1.50
-11	39,6	1.56
-12	44,4	1.75
-28	46,0	1.81
-13	50,8	2.00
-29	52,3	2.06
-14	57,1	2.25
-30	63,5	2.50
-31	66,8	2.63
-15	69,8	2.75
-16	73,1	2.88
-17	90,4	3.56

FF90311

Heavy Duty Hose Support Clamps

These heavy duty weld-based clamps are designed to securely hold hose in applications subject to impulsing, flexing and vibrating conditions. The clamps help prevent abrasion and extend hose life through proper routing. Clamps are rated to ambient temperature of +250°F. See pages 300-308 for detailed clamp to hose part number reference.

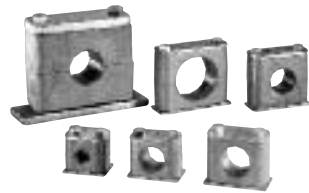

CLAMP P/N

INSIDE DIAMETER

CLAMP P/N	INSIDE DIAMETER	
	mm	in
FF90311-127	12,7	0.50
FF90311-137	13,7	0.54
FF90311-150	15,0	0.59
FF90311-160	16,0	0.63
FF90311-171	17,1	0.67
FF90311-174	17,4	0.69
FF90311-190	19,0	0.75
FF90311-205	20,5	0.81
FF90311-222	22,2	0.87
FF90311-239	23,9	0.94
FF90311-254	25,4	1.00
FF90311-266	26,6	1.05
FF90311-280	28,0	1.10
FF90311-300	30,0	1.18
FF90311-320	32,0	1.26
FF90311-334	33,4	1.31
FF90311-357	35,7	1.41
FF90311-381	38,1	1.50
FF90311-400	40,0	1.57
FF90311-422	42,2	1.66
FF90311-445	44,5	1.75
FF90311-483	48,3	1.90
FF90311-508	50,8	2.00
FF90311-572	57,2	2.25
FF90311-635	63,5	2.50
FF90311-700	70,0	2.76

FF90308

Hose Insertion Gages

Improve hose assembly reliability with these easy to use aluminum gages that are designed to ensure proper fitting depth during pre-assembly.

Simply bottom the hose in the appropriately marked cavity and scribe a mark on the hose flush with the top surface of the gauge. Insert the fitting until the back of the socket is aligned with scribe line.



For use with all hoses that mate with TTC, TTC12 and Global Spiral TTC fittings

PART NUMBER	USAGE
FF90308-01	For use with all hoses that mate with -4 through -16 TTC and TTC12 fittings
FF90308-02	For use with all hoses that mate with -20 through -32 TTC and TTC 12 fittings
FF90308-03	For use with all hoses that mate with -12, -16, -20 Spiral TTC fittings

SPECIALTY & TRUCK HOSE

LOW & MEDIUM PRESSURE HOSE

HIGH PRESSURE HOSE

HOSE FITTINGS

ADAPTERS & TUBE FITTINGS

ACCESSORIES & ASSEMBLY INSTRUCTIONS

HOSE ASSEMBLY EQUIPMENT

APPENDICES

Hose Protectors

PART NUMBER	DESCRIPTION
HP4*	4" Hose Protector Case of 50
HP6*	6" Hose Protector Case of 50
HP8*	8" Hose Protector Case of 50
HPM*	Mixed Hose Protectors Case of 60

*Hose protectors available in black, orange or yellow.



Abrasion Protection For:

- Hydraulic Hoses
- Battery Cables
- Wiring Harness
- Brake Systems
- Fuel Lines
- Air Lines
- Radiator Hoses
- Oil Lines

Features:

- Extremely high wear factor
- Formulated to resist solvents, oils, grease, gasoline, etc.
- 3 grooves protect cable ties and prevent slipping
- Operating temperature range is -40° to 430°F.
- Exceptionally cost effective
- Easy installation in minutes – no need to remove hose
- Packed in easy to assemble, colorful, counter display box
- Available in 3 sizes – 4", 6" and 8" – cable ties included

Market Applications:

- Farming
- Industrial
- Trucking
- Mining
- Construction
- Aviation Support
- Public Transportation
- Road Maintenance
- Waste Management
- Original Equip. Manuf.

Hose Spacers

PART NUMBER	DESCRIPTION
HSM-48	Case of 48 mixed Hose Spacers

Features:

- Prevents hose abrasion at points of contact
- Helps keep hoses organized
- Prevents damage from unrestrained hoses
- Easy to install
- Available in 4 sizes – 3/4", 1", 1 1/8", 1 3/8"
- Packed in colorful counter display boxes of 48 – cable ties included
- Also available in mixed boxes of 48 (12 each size) or refill bags of 12



Hose Looms

PART NUMBER	DESCRIPTION
HLM-48	Case of 48 mixed Hose Looms

Features:

- Prevents hose abrasion at points of contact
- Keeps multiple hoses organized
- Simplifies hose routing
- Prevents damage from unrestrained hoses
- Easy to install
- Available in 4 sizes – 3/4", 1", 1 1/8", 1 3/8"
- Packed in colorful counter display boxes of 48
- Also available in mixed boxes of 48 (12 each size) or refill bags of 12



Flaretite* Seals

The ideal product to enhance new installations of SAE 37° connections, as well as seal off minor leaks and weeping connections.



Features

- Ribbed insert design
- Coated with Loctite** sealant
- Economical method to reduce minor leaks and weeping connections
- Built-in clip to attach the Flaretite seal to the nose of the SAE 37 degree connection
- Available sizes: -04 through -32

Benefits

- Multiple surface contact points
- Locks the joint and fills surface imperfections
- Saves time & money associated with maintenance and rework
- Quick & easy assembly

Flaretite Seal Joint Section of Applied Seal

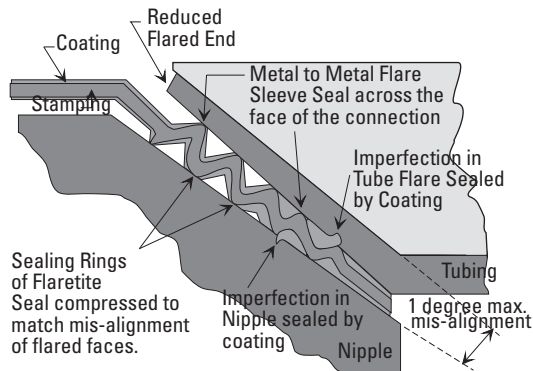

Standard Flared Connection (Section)

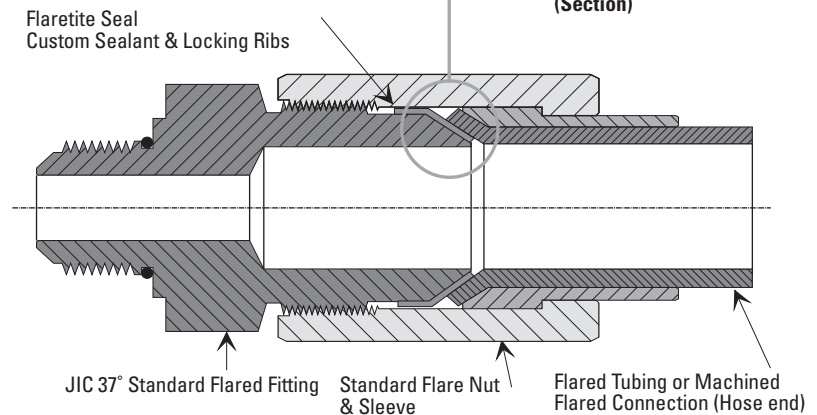

SEAL SIZE	PACKAGE PART NUMBER	NUMBER OF SEALS PER PACKAGE
-04	FF13267	100
-06	FF13268	100
-08	FF13269	100
-10	FF13270	100
-12	FF13271	100
-16	FF13272	50
-20	FF13273	50
-24	FF13570	25
-32	FF13571	10

Assembly and Torque Requirements

To assemble an SAE 37° connection using a Flaretite seal, simply push the Flaretite seal onto the male portion of the connection. The built-in clip will hold the Flaretite seal onto the male half.

During assembly ensure:

- The seal is fitted squarely to the conical nose of the JIC fitting -37° flare.
- The sealing faces of the flared connector part are clean and free of burrs.
- The flared joint is correctly tightened with recommended torque settings noted below.

RECOMMENDED TORQUE SETTINGS:

Tolerance: +10% -0%					
-04 (1/4")	SAE 37°: 14lb-ft.	-10 (5/8")	SAE 37°: 80lb-ft.	-20 (1-1/4")	SAE 37°: 190lb-ft.
-06 (3/8")	SAE 37°: 26lb-ft.	-12 (3/4")	SAE 37°: 110lb-ft.	-24 (1-1/2")	SAE 37°: 220lb-ft.
-08 (1/2")	SAE 37°: 55lb-ft.	-16 (1")	SAE 37°: 140lb-ft.	-32 (2")	SAE 37°: 325lb-ft.

* Flaretite is a registered trademark of Flaretite Inc.

All photos and the name Flaretite are the property of Flaretite Inc.

** Loctite is a registered trademark of Henkel Loctite Corporation.

SPECIALTY & TRUCK HOSE

LOW & MEDIUM PRESSURE HOSE

HIGH PRESSURE HOSE

HOSE FITTINGS

ADAPTERS & TUBE FITTINGS

ACCESSORIES & ASSEMBLY INSTRUCTIONS

HOSE ASSEMBLY EQUIPMENT

APPENDICES

Accessories to Hose Chart

SPECIALTY &
TRUCK HOSE

Part #	Steel Prot. Coil Spring* 900564 (dash size)	Plastic Coil Sleeve 900952 (dash size)	Steel Prot. Coil Sleeve* 900705 (dash size)	Support Clamp 900729 (dash size)	Internal Support Coil	Nylon Sleeve* FC425 (dash size)	Firesleeve* 624 (dash size)	Firesleeve Clamp FF9217 (dash size)	Heavy Duty Support Clamp FF9031 (dash size)
302A16	-6S	-16	-6S	-27	222005-14C	-24	-24	-0648S	-320
302A20	-7S	-22	-7S	-10	222005-15C	-28	-30	-0648S	-381
302A24	-9S	-22	-9S	-12	222005-17C	-32	-32	-0648S	-445
302A32	-10S	-30	-10S	-14	222005-18C	-38	-38	-0648S	-572
303-4	-1S	-6	-1S	-1		-12	-11	-0622S	-127
303-5	-12S	-8	-13S	-2		-12	-12	-0622S	-150
303-6	-2S	-10	-2S	-21		-16	-14	-0622S	-174
303-8	-14S	-12	-3S	-4	222005-10C	-16	-16	-0622S	-190
303-10	-4S	-12	-4S	-6	222005-21C	-20	-18	-0630S	-239
303-12	-5S	-16	-5S	-8	222005-13C	-20	-20	-0630S	-280
1503-4	-1S	-6	-1S	-1		-12	-11	-0622S	-137
1503-5	-12S	-8	-13S	-2		-12	-12	-0622S	
1503-6	-2S	-10	-2S	-21		-16	-14	-0622S	-174
1503-8	-14S	-12	-3S	-4	222005-10C	-16	-16	-0622S	-190
1503-10	-4S	-12	-4S	-6	222005-21C	-20	-18	-0630S	-239
1503-12	-5S	-16	-5S	-8	222005-13C	-20	-20	-0630S	-280
1503-16	-6S	-16	-6S	-27	222005-14C	-24	-24	-0648S	-320
1503-20	-7S	-22	-7S	-10	222005-15C	-28	-30	-0648S	-381
1503-24	-9S	-22	-9S	-12	222005-17C	-32	-32	-0648S	-445
1503-32	-10S	-30	-10S	-14	222005-18C	-38	-38	-0648S	-572
1503-40			-12S	-16	222005-19C				
1531-10	-4S	-12	-4S	-6		-20	-16	-0622S	-239
1531-12	-5S	-16	-5S	-8		-20	-20	-0630S	-280
1531-16	-7S	-16	-6S	-25		-24	-24	-0630S	-357
1531-20	-7S	-22	-7S	-10		-28	-30	-0648S	-422
1531A-24	-6S	-16	-5S	-9		-24	-32	-0648S	-483
2550-6	-14S	-10	-3S	-4		-16	-13	-0622S	-174
2554-6	-14S	-10	-2S	-4		-16	-13	-0622S	-174
2555-6	-14S	-10	-2S	-4		-16	-13	-0622S	-190
2556-4	-1S	-6	-1S	-1		-12	-9	-0622S	-127
2556-6	-12S	-8	-13S	-21		-16	-11	-0622S	-160
2556-8	-14S	-10	-3S	-4		-16	-13	-0622S	-190
2556-10	-4S	-12	-4S	-5		-16	-16	-0622S	-222
2556-12	-5S	-16	-5S	-23		-20	-18	-0630S	-266
2565-4	-1S	-6	-1S	-1		-12	-9	-0622S	-127
2565-6	-12S	-8	-13S	-21		-16	-11	-0622S	-160
2565-8	-14S	-10	-3S	-4		-16	-13	-0622S	-205
2565-10	-4S	-12	-4S	-6		-16	-16	-0622S	-239
2565-12	-5S	-16	-5S	-8		-20	-18	-0630S	-280
2570-6	-14S	-10	-3S	-4		-16	-13	-0622S	-174
2570-8	-4S	-12	-4S	-6	222005-11C	-16	-18	-0622S	-190
2570-10	-5S	-16	-5S	-8	222005-13C	-20	-20	-0648S	-239
2575-4	-1S	-6	-1S	-1		-12	-9	-0622S	-127
2575-6	-12S	-8	-13S	-21		-16	-11	-0622S	-160
2575-8	-14S	-10	-3S	-4		-16	-13	-0622S	-190
2575-10	-4S	-12	-4S	-6		-20	-16	-0622S	-222
2575-12	-5S	-16	-5S	-23		-20	-18	-0630S	-266
2580-4	-1S	-6	-1S	-1		-12	-11	-0622S	-127
2580-5	-12S	-8	-13S	-2		-12	-12	-0622S	-150
2580-6	-2S	-10	-2S	-21		-16	-14	-0622S	-174
2580-8	-14S	-12	-3S	-4	222005-10C	-16	-16	-0622S	-190
2580-10	-4S	-12	-4S	-6	222005-21C	-20	-18	-0630S	-239

*Sizes indicated are based on Hose O.D. only. If sleeve is to be placed over fittings, a larger sleeve size may be required, depending on type of fitting used.

LOW & MEDIUM
PRESSURE HOSE

HIGH PRESSURE HOSE

HOSE FITTINGS

ADAPTERS &
TUBE FITTINGS

ACCESSORIES &
ASSEMBLY INSTRUCTIONS

HOSE ASSEMBLY
EQUIPMENT

APPENDICES

Accessories to Hose Chart

Part #	Steel Prot. Coil Spring* 900564 (dash size)	Plastic Coil Sleeve 900952 (dash size)	Steel Prot. Coil Sleeve* 900705 (dash size)	Support Clamp 900729 (dash size)	Internal Support Coil	Nylon Sleeve* FC425 (dash size)	Firesleeve* 624 (dash size)	Firesleeve Clamp FF9217 (dash size)	Heavy Duty Support Clamp FF9031 (dash size)
2580-12	-5S	-16	-5S	-8	222005-13C	-20	-20	-0630S	-280
2580-16	-6S	-16	-6S	-27	222005-14C	-24	-24	-0648S	-320
2580-20	-7S	-22	-7S	-10	222005-15C	-28	-28	-0648S	-381
2580-24	-9S	-22	-9S	-12	222005-17C	-32	-32	-0648S	-445
2580-32	-10S	-30	-10S	-14	222005-18C	-40	-42	-0648S	-572
2583-4	-1S	-8	-1S	-2		-12	-11	-0622S	-150
2583-6	-14S	-10	-3S	-4		-16	-16	-0622S	-190
2583-8	-4S	-12	-4S	-6		-20	-20	-0648S	-239
2583-12	-6S	-16	-14S	-24		-24	-24	-0648S	-320
2583-16	-7S	-22	-7S	-10		-28	-28	-0648S	-381
2583-20	-8S	-22	-9S	-12		-32	-32	-0648S	-445
2651-4	-1S	-6	-1S	-1		-12	-11	-0622S	-137
2651-5	-12S	-8	-13S	-2		-12	-12	-0622S	
2651-6	-2S	-10	-2S	-21		-16	-14	-0622S	-174
2651-8	-14S	-12	-3S	-4	222005-10C	-16	-16	-0622S	-190
2651-10	-4S	-12	-4S	-6	222005-21C	-20	-18	-0630S	-239
2651-12	-5S	-16	-5S	-8	222005-13C	-20	-20	-0630S	-280
2651-16	-6S	-16	-6S	-27	222005-14C	-24	-24	-0648S	-320
2651-20	-7S	-22	-7S	-10	222005-15C	-28	-30	-0648S	-381
2651-24	-9S	-22	-9S	-12	222005-17C	-32	-32	-0648S	-445
2651-32	-10S	-30	-10S	-14	222005-18C	-38	-42	-0648S	-572
2651-40			-12S	-16	222005-19C	-54	-50	-0664C	
2661-12	-6S	-16	-14s	-24		-24	-24	-0630S	-320
2661-16	-7S	-22	-7S	-10		-28	-28	-0648S	-381
2661-20	-8S	-22	-9S	-12		-32	-32	-0648S	-445
2661-24	-10S	-30	-15S	-29		-38	-38	-0648S	-508
2661-32	-13S		-16S	-30		-46	-46	-0664C	-635
2661-40						-54	-54	-0664C	
2661-48							-60		
2661-64									
2681-3	-1S	-6	-1S	-1		-12	-11	-0622S	
2681-4	-12S	-8	-13S	-21		-16	-12	-0622S	-160
2681-5	-2S	-8	-2S	-3		-16	-14	-0630S	
2681-6	-14S	-10	-3S	-4		-16	-18	-0630S	-205
2681-8	-4S	-12	-4S	-5		-20	-20	-0630S	-222
2681-10	-5S	-12	-5S	-23		-20	-20	-0630S	-266
2681-12	-6S	-16	-14S	-27	222005-14C	-24	-22	-0648S	-300
2681-16	-7S	-22	-7S	-10	222005-15C	-28	-28	-0648S	-381
2681-20	-8S	-22	-9S	-28	222005-17C	-32	-38	-0648S	-445
2681-24	-10S	-30	-15S	-29	222005-18C	-38	-38	-0648S	-508
2681-32	-13S	-30	-11S	-31	222005-19C	-46	-46	-0664C	-635
2781-4	-2S	-8	-2S	-3		-16	-14	-0622S	-174
2781-6	-3S	-12	-3S	-5		-16	-16	-0630S	-222
2781-8	-4S	-12	-4S	-6		-20	-18	-0630S	-239
2781-10	-5S	-16	-5S	-8		-20	-20	-0630S	-280
2781-12	-6S	-16	-6S	-24		-24	-26	-0648S	-320
2781-16	-7S	-22	-7S	-11		-28	-30	-0648S	-400
2781-20	-8S	-30	-8S	-13		-38	-38	-0648S	-508
2781-24	-10S	-30	-10S	-14		-40	-42	-0648S	-572
2781-32	-11S	-30	-11S	-15		-54	-46	-0664C	-700
2807-3		-4		-18			-7	-0622S	
2807-4		-4		-18			-8	-0622S	

SPECIALTY &
TRUCK HOSE

LOW & MEDIUM
PRESSURE HOSE

HIGH PRESSURE HOSE

HOSE FITTINGS

ADAPTERS &
TUBE FITTINGS

ACCESSORIES &
ASSEMBLY INSTRUCTIONS

HOSE ASSEMBLY
EQUIPMENT

APPENDICES

*Sizes indicated are based on Hose O.D. only. If sleeve is to be placed over fittings, a larger sleeve size may be required, depending on type of fitting used.

Accessories to Hose Chart

SPECIALTY &
TRUCK HOSE

Part #	Steel Prot. Coil Spring* 900564 (dash size)	Plastic Coil Sleeve 900952 (dash size)	Steel Prot. Coil Sleeve* 900705 (dash size)	Support Clamp 900729 (dash size)	Internal Support Coil	Nylon Sleeve* FC425 (dash size)	Firesleeve* 624 (dash size)	Firesleeve Clamp FF9217 (dash size)	Heavy Duty Support Clamp FF9031 (dash size)
--------	---	--	---	----------------------------------	-----------------------	---------------------------------	-----------------------------	-------------------------------------	---

LOW & MEDIUM
PRESSURE HOSE

2807-5		-4		-19			-9	-0622S	
2807-6		-6	-17S	-01	222005-23C		-10	-0622S	
2807-8	-1S	-8	-1S	-1	222005-10C	-12	-12	-0622S	-137
2807-10	-2S	-8	-3S	-21	222005-21C	-16	-14	-0630S	-160
2807-12	-2S	-10	-3S	-4	222005-13C	-16	-16	-0630S	-190
2807-16	-3S	-12	-5S	-23	222005-14C	-20	-20	-0630S	-266
2807-20	-5S	-16	-6S	-24	222005-15C	-24	-24	-0648S	-320
2808-8	-12S	-6	-1S	-2	222005-10C	-12	-16	-0622S	-150
2808-10	-2S	-8	-2S	-3	222005-21C	-16	-18	-0630S	-174
2808-12	-14S	-10	-3S	-5	222005-13C	-16	-20	-0630S	-205
2808-16	-5S	-16	-5S	-8	222005-14C	-20	-26	-0648S	-280
2808-20	-7S	-16	-6S	-25	222005-15C	-24	-32	-0648S	-334
2808-24	-7S	-22	-7S	-11	222005-17C	-28	-38	-0648S	-422

HIGH PRESSURE HOSE

CR170-4	-1S	-6	-1S	-1		-12	-11	-0622S	
CR170-6	-2S	-10	-2S	-21		-16	-14	-0622S	
CR170-8	-14S	-12	-3S	-4	222005-10C	-16	-16	-0622S	
FC194-04	-12S	-8	-13S	-21		-16	-12	-0622S	-160
FC194-06	-14S	-10	-3S	-4		-16	-18	-0622S	-205
FC194-08	-4S	-12	-4S	-5		-20	-20	-0630S	-222
FC194-10	-5S	-12	-5S	-23		-20	-20	-0630S	-266
FC194-12	-6S	-16	-14S	-27		-24	-22	-0648S	-300
FC194-16	-7S	-22	-7S	-10		-28	-26	-0648S	-381
FC194-20	-8S	-22	-9S	-28		-32	-32	-0648S	-445
FC195-04	-2S	-8	-2S	-3		-16	-14	-0622S	-174
FC195-06	-3S	-12	-3S	-5		-16	-16	-0622S	-222
FC195-08	-4S	-12	-4S	-6		-20	-18	-0630S	-239
FC195-10	-5S	-16	-5S	-8		-20	-20	-0630S	-280
FC195-12	-6S	-16	-6S	-24		-24	-26	-0630S	-320
FC195-16	-7S	-22	-7S	-11		-28	-30	-0648S	-400
FC195-20	-8S	-30	-8S	-13		-38	-38	-0648S	-500
FC195-24	-10S	-30	-10S	-14		-38	-42	-0648S	-572
FC195-32	-11S	-30	-11S	-15		-54	-46	-0648S	-700

HOSE FITTINGS

ADAPTERS &
TUBE FITTINGS

ACCESSORIES &
ASSEMBLY INSTRUCTIONS

HOSE ASSEMBLY
EQUIPMENT

APPENDICES

*Sizes indicated are based on Hose O.D. only. If sleeve is to be placed over fittings, a larger sleeve size may be required, depending on type of fitting used.

Accessories to Hose Chart

Part #	Steel Prot. Coil Spring* 900564 (dash size)	Plastic Coil Sleeve 900952 (dash size)	Steel Prot. Coil Sleeve* 900705 (dash size)	Support Clamp 900729 (dash size)	Internal Support Coil	Nylon Sleeve* FC425 (dash size)	Firesleeve* 624 (dash size)	Firesleeve Clamp FF9217 (dash size)	Heavy Duty Support Clamp FF9031 (dash size)
FC234-05	-1S	-10	-2S	-21		-12	-11	-0622S	-150
FC234-06	-2S	-12	-3S	-4		-12	-12	-0622S	-174
FC234-08	-3S	-12	-4S	-4	222005-10C	-16	-12	-0622S	-190
FC234-10	-4S	-16	-5S	-23	222005-21C	-16	-13	-0622S	-239
FC234-12	-5S	-16	-14S	-9	222005-13C	-20	-16	-0630S	-280
FC234-16	-6S	-22	-7S	-24	222005-14C	-20	-20	-0630S	-320
FC252-08									-205
FC252-10									-239
FC252-12									-266
FC252-16									-334
FC254-08	-4S	-12	-4S	-6		-20	-18	-0630S	-254
FC254-12	-6S	-16	-6S	-24		-24	-26	-0648S	-320
FC254-16	-7S	-22	-7S	-10		-28	-30	-0648S	-381
FC254-20	-8S	-22	-9S	-28		-32	-32	-0648S	-445
FC254-24	-10S	-30	-10S	-29		-38	-38	-0648S	-700
FC254-32	-10S	-30	-11S	-31		-54	-46	-0664C	-700
FC273-12	-6S	-16	-6S	-24		-24	-26	-0648S	-320
FC273-16	-7S	-22	-7S	-10		-28	-30	-0648S	-381
FC273-20	-8S	-30	-8S	-13		-38	-38	-0648S	-508
FC273-24	-10S	-30	-10S	-14		-40	-42	-0664C	-572
FC273-32	-11S			-16		-54	-46	-0664C	-700
FC300-04	-1S	-6	-1S	-1		-12	-11	-0622S	-137
FC300-05	-12S	-8	-13S	-2		-12	-12	-0622S	
FC300-06	-2S	-10	-2S	-21		-16	-14	-0622S	-174
FC300-08	-14S	-12	-3S	-4	222005-10C	-16	-16	-0622S	-190
FC300-10	-4S	-12	-4S	-6	222005-21C	-20	-18	-0630S	-239
FC300-12	-5S	-16	-5S	-8	222005-13C	-20	-20	-0630S	-280
FC300-16	-6S	-16	-6S	-27	222005-14C	-24	-24	-0648S	-320
FC300-20	-7S	-22	-7S	-10	222005-15C	-28	-30	-0648S	-381
FC300-24	-9S	-22	-9S	-12	222005-17C	-32	-32	-0648S	-445
FC300-32	-10S	-30	-10S	-14	222005-18C	-38	-38	-0648S	-572
FC300-40			-12S	-16	222005-19C				
FC310-04	-12S	-6	-1S	-2		-12	-12	-0622S	-137
FC310-06	-14S	-10	-2S	-4		-12	-16	-0622S	-174
FC310-08	-3S	-12	-3S	-5		-16	-16	-0630S	-205
FC310-10	-4S	-12	-4S	-6		-20	-18	-0630S	-239
FC310-12	-5S	-16	-5S	-8		-20	-22	-0630S	-280
FC310-16	-7S	-16	-6S	-25		-24	-24	-0648S	-357
FC310-20	-9S	-30	-8S	-12		-32	-30	-0648S	-422
FC318-12	-6S	-16	-14s	-24		-24	-24	-0630S	-320
FC321-04	-1S	-6	-1S	-1		-12	-11	-0622S	-137
FC321-05	-12S	-8	-13S	-2		-12	-12	-0622S	-150
FC321-06	-2S	-10	-2S	-21		-16	-14	-0622S	-174
FC321-08	-14S	-12	-3S	-4	222005-10C	-16	-16	-0622S	-190
FC321-10	-4S	-12	-4S	-5	222005-11C	-20	-18	-0630S	-239
FC321-12	-5S	-16	-5S	-8	222005-13C	-20	-20	-0630S	-280
FC321-16	-6S	-16	-6S	-27	222005-14C	-24	-22	-0630S	-320
FC323-12	-5S	-16	-14S	-27		-24	-24	-0643S	-300
FC323-16	-6S	-22	-7S	-25		-28	-28	-0643S	-381
FC323-20	-8S	-30	-15S	-28		-32	-32	-0648S	
FC323-24	-10S	-30	-10S	-29		-38	-38	-0648S	

*Sizes indicated are based on Hose O.D. only. If sleeve is to be placed over fittings, a larger sleeve size may be required, depending on type of fitting used.

Accessories to Hose Chart

SPECIALTY &
TRUCK HOSE

LOW & MEDIUM
PRESSURE HOSE

HIGH PRESSURE HOSE

HOSE FITTINGS

ADAPTERS &
TUBE FITTINGS

ACCESSORIES &
ASSEMBLY INSTRUCTIONS

HOSE ASSEMBLY
EQUIPMENT

APPENDICES

Part #	Steel Prot. Coil Spring* 900564 (dash size)	Plastic Coil Sleeve 900952 (dash size)	Steel Prot. Coil Sleeve* 900705 (dash size)	Support Clamp 900729 (dash size)	Internal Support Coil	Nylon Sleeve* FC425 (dash size)	Firesleeve* 624 (dash size)	Firesleeve Clamp FF9217 (dash size)	Heavy Duty Support Clamp FF9031 (dash size)
FC323-32	-13S	-30	-11S	-31		-46	-46	-0664C	
FC324-08	-4S	-12	-4S	-6		-20	-18	-0622S	-239
FC324-12	-6S	-16	-14S	-27		-24	-26	-0648S	-300
FC324-16	-7S	-22	-7S	-10		-28	-30	-0648S	-381
FC325-12	-6S	-16	-6S	-24		-24	-26	-0648S	-320
FC325-16	-7S	-22	-7S	-10		-28	-30	-0648S	-381
FC332-04	-1S	-6	-1S			-12	-9	-0622S	-127
FC332-06	-12S	-8	-13S	-21		-16	-11	-0622S	-160
FC332-08	-14S	-10	-3S	-4		-16	-13	-0622S	-190
FC332-10	-3S	-12	-4S	-5		-20	-16	-0622S	-222
FC332-12	-5S	-12	-5S	-23		-20	-18	-0630S	-266
FC350-04	-1S	-6	-1S	-1		-12	-11	-0622S	-127
FC350-05	-12S	-8	-13S	-2		-12	-12	-0622S	-150
FC350-06	-2S	-10	-2S	-21		-16	-14	-0622S	-174
FC350-08	-14S	-12	-3S	-4	222005-10C	-16	-16	-0622S	-190
FC350-10	-4S	-12	-4S	-6	222005-21C	-20	-18	-0630S	-239
FC350-12	-16S	-5	-5S	-8	222005-13C	-20	-20	-0630S	-280
FC350-16	-6S	-16	-6S	-27	222005-14C	-24	-24	-0648S	-320
FC350-20	-7S	-22	-7S	-10	222005-15C	-28	-30	-0648S	-381
FC350-24	-9S	-22	-9S	-12	222005-17C	-32	-32	-0648S	-445
FC352-08									-239
FC352-10									-266
FC352-12									-300
FC352-14									-334
FC352-16									-357
FC352-18									-400
FC352-20									-422
FC352-22									-445
FC352-24									-508
FC352-26									-508
FC352-28									-572
FC352-32									-635
FC352-36									-700
FC352-38									
FC352-40									
FC352-44									
FC352-48									
FC352-56									
FC352-64									
FC355-04	-1S	-6	-1S	-1		-12	-11	-0622S	-127
FC355-05	-1S	-6	-2S	-1		-12	-11	-0622S	-150
FC355-06	-12S	-8	-1S	-2		-12	-12	-0622S	-174
FC355-08	-2S	-10	-13S	-3		-16	-12	-0622S	-190
FC355-10	-3S	-12	-3S	-5	222005-10C	-16	-13	-0622S	-239
FC355-12	-4S	-6	-5S-4S	-6	222005-21C	-20	-16	-0630S	-280
FC355-16	-5S	-16	-6S	-9	222005-13C	-20	-20	-0630S	-320
FC355-20	-6S	-22	-7S	-24	222005-14C	-24	-22	-0648S	-381
FC355-24	-7S	-22	-7S	-10	222005-15C	-28	-30	-0648S	-445
FC355-32	-9S	-22	-9S	-12	222005-17C	-32	-32	-0648S	-572
FC363-08	-15S	-10	-4S	-5		-16	-14	-0622S	-190
FC363-12	-5S	-16	-6S	-8		-20	-20	-0630S	-266

*Sizes indicated are based on Hose O.D. only. If sleeve is to be placed over fittings, a larger sleeve size may be required, depending on type of fitting used.

Accessories to Hose Chart

Part #	Steel Prot. Coil Spring* 900564 (dash size)	Plastic Coil Sleeve 900952 (dash size)	Steel Prot. Coil Sleeve* 900705 (dash size)	Support Clamp 900729 (dash size)	Internal Support Coil	Nylon Sleeve* FC425 (dash size)	Firesleeve* 624 (dash size)	Firesleeve Clamp FF9217 (dash size)	Heavy Duty Support Clamp FF9031 (dash size)
FC363-16	-6S	-16	-7S	-10		-24	-22	-0630S	-320
FC363-20	-7S	-22	-9S	-11		-28	-26	-0648S	-381
FC363-24	-9S	-22	-8S	-2S		-32	-30	-0648S	-445
FC363-32	-10S		-16S	-30		-59	-42	-0648S	-572
FC364-08	-15S	-10	-4S	-5		-16	-14	-0622S	-190
FC364-12	-5S	-16	-6S	-8		-20	-20	-0630S	-266
FC364-16	-6S	-22	-7S	-10		-24	-22	-0630S	-320
FC364-20	-7S	-30	-9S	-11		-28	-26	-0648S	-381
FC364-24	-9S	-30	-8S	-28		-32	-30	-0648S	-445
FC364-32	-10S		-16S	-30		-59	-42	-0648S	-572
FC364-40	-11S	-30	-12S	-16		-54	-50	-0664S	-635
FC364-48									
FC465-03		-4		-18			-9	-0622S	
FC465-04		-4		-18			-9	-0622S	
FC465-05		-4		-19			-10	-0622S	
FC465-06		-6		-01	222005-23C	-12	-11	-0622S	
FC465-08	-1S	-8	-1S	-1	222005-10C	-12	-13	-0622S	-137
FC465-10	-1S	-8	-13S	-21	222005-21C	-16	-14	-0622S	-160
FC465-12	-2S	-10	-3S	-4	222005-13C	-16	-16	-0622S	-190
FC465-16	-3S	-12	-5S	-23	222005-14C	-20	-20	-0648S	-266
FC465-20	-5S	-16	-6S	-24	222005-15C	-24	-24	-0648S	-320
FC466-04	-1S	-6	-1S	-1		-12	-9	-0622S	-127
FC466-06	-12S	-8	-13S	-21		-16	-11	-0622S	-160
FC466-08	-14S	-10	-3S	-4		-16	-13	-0622S	-190
FC466-10	-3S	-12	-4S	-5		-20	-16	-0622S	-222
FC466-12	-5S	-12	-5S	-23		-20	-18	-0630S	-266
FC469-06	-1S	-6	-1S	-1	222005-23C	-12	-12	-0622S	
FC469-08	-1S	-8	-13S	-21	222005-10C	-16	-14	-0622S	
FC469-10	-12S	-10	-2S	-4	222005-21C	-16	-16	-0622S	-150
FC498-04	-1S	-6	-1S	-1		-12	-9	-0622S	-127
FC498-06	-12S	-8	-13S	-21		-16	-11	-0622S	-160
FC498-08	-14S	-10	-3S	-4		-16	-13	-0622S	-190
FC498-10	-4S	-12	-4S	-5		-20	-16	-0622S	-222
FC498-12	-5S	-12	-5S	-23		-20	-18	-0630S	-266
FC510-04	-12S	-6	-1S	-2		-12	-12	-0622S	
FC510-06	-14S	-10	-2S	-4		-16	-16	-0622S	-174
FC510-08	-3S	-12	-3S	-5		-16	-16	-0630S	-205
FC510-10	-4S	-12	-4S	-6		-20	-18	-0630S	-239
FC510-12	-5S	-16	-5S	-8		-20	-22	-0630S	-280
FC510-16	-7S	-16	-6S	-25		-24	-24	-0630S	-334
FC510-20	-9S	-30	-8S	-12		-32	-30	-0648S	-422
FC563-08	-15S	-12	-3S	-5		-16	-16	-0622S	-205
FC563-12	-5S	-16	-14S	-9		-20	-22	-0648S	-280
FC563-16	-6S	-16	-6S	-2S		-24	-26	-0648S	-334
FC563-20	-7S	-22	-7S	-11		-28	-30	-0648S	
FC563-24	-9S	-22	-9S	-28		-32	-32	-0648S	
FC563-32	-10S	-30	-10S	-14		-40	-42	-0648S	
FC579-04	-2S	-8	-2S	-3		-16	-14	-0622S	-174
FC606-16	-7S	-22	-7S	-10	222005-15C	-28	-30	-0648S	-422
FC606-20	-8S	-30	-8S	-13	222005-17C	-38	-38	-0648S	-508
FC606-24	-10S	-30	-10S	-14	222005-18C	-40	-42	-0648S	-572
FC611-04	-1S	-6	-1S	-1		-12	-11	-0622S	-137

*Sizes indicated are based on Hose O.D. only. If sleeve is to be placed over fittings, a larger sleeve size may be required, depending on type of fitting used.

Accessories to Hose Chart

SPECIALTY &
TRUCK HOSE

LOW & MEDIUM
PRESSURE HOSE

HIGH PRESSURE HOSE

HOSE FITTINGS

ADAPTERS &
TUBE FITTINGS

ACCESSORIES &
ASSEMBLY INSTRUCTIONS

HOSE ASSEMBLY
EQUIPMENT

APPENDICES

Part #	Steel Prot. Coil Spring* 900564 (dash size)	Plastic Coil Sleeve 900952 (dash size)	Steel Prot. Coil Sleeve* 900705 (dash size)	Support Clamp 900729 (dash size)	Internal Support Coil	Nylon Sleeve* FC425 (dash size)	Firesleeve* 624 (dash size)	Firesleeve Clamp FF9217 (dash size)	Heavy Duty Support Clamp FF9031 (dash size)
FC611-06	-15S	-10	-2S	-3		-16	-14	-0622S	-174
FC611-08	-3S	-10	-3S	-5		-16	-16	-0630S	-205
FC611-12	-5S	-16	-5S	-8		-24	-24	-0630S	-280
FC611-16	-7S	-22	-6S	-25		-24	-24	-0648S	-357
FC611-20	-9S	-30	-8S	-12		-32	-30	-0648S	-422
FC611-24	-8S	-30	-8S	-13		-38	-38	-0648S	-483
FC611-32	-13S	-30	-12S	-30	222005-19C	-46	-46	-0664C	-635
FC619-12	-6S	-16	-6S	-27		-24	-26	-0648S	-300
FC619-16	-6S	-22	-7S	-25		-28	-28	-0643S	-381
FC619-20	-8S	-22	-9S	-12		-32	-32	-0648S	-445
FC619-24	-10S	-30	-15S	-29		-38	-38	-0648S	-508
FC619-32	-13S		-16S	-30		-46	-46	-0664C	-635
FC636-12	-5S	-16	-14S	-27		-24	-24	0643S	-300
FC636-16	-6S	-22	-7S	-25		-28	-28	-0643S	-381
FC636-20	-8S	-22	-10S	-28	222005-17C	-32	-38	-0648S	
FC636-24	-8S	-30	-10S	-29	222005-18C	-38	-38	-0648S	
FC639-04	-1S	-6	-1S	-1		-12	-11	-0622S	-137
FC639-06	-2S	-10	-2S	-3		-16	-14	-0622S	-174
FC639-08	-15S	-10	-3S	-5		-16	-16	-0622S	-205
FC639-10	-54S	-16	-5S	-6		-20	-20	-0630S	-239
FC639-12	-5S	-16	-6S	-9	222005-14C	-22	-22	-0648S	-280
FC639-16	-7S	-22	-7S	-10	222005-15C	-24	-28	-0648S	-357
FC645-06		-6	-17S	-01	222005-23C		-10	-0622S	
FC647-04	-1S	-6	-1S	-1		-12	-9	-0622S	-127
FC647-06	-12S	-8	-13S	-21		-16	-11	-0622S	-160
FC647-08	-14S	-10	-3S	-4		-16	-13	-0622S	-190
FC647-10	-3S	-12	-4S	-5		-20	-16	-0622S	-222
FC647-12	-5S	-12	-5S	-23		-20	-18	-0630S	-266
FC650-04	-1S	-6	-1S	-1		-12	-11	-0622S	
FC650-06	-2S	-10	-2S	-21		-16	-14	-0622S	-160
FC650-08	-14S	-12	-3S	-4	222005-10C	-16	-16	-0622S	-190
FC650-10		-12	-3S	-5		-16	-16	-0622S	-205
FC650-12	-54S	-16	-5S	-6		-20	-20	-0630S	-254
FC659-06	-3S	-12	-3S	-5		-16	-16	-0630S	-205
FC659-08	-4S	-12	-4S	-6		-20	-18	-0630S	-239
FC659-10	-5S	-16	-5S	-8		-20	-20	-0630S	-280
FC659-12	-6S	-16	-6S	-24		-24	-26	-0630S	-300
FC659-16	-7S	-22	-7S	-11		-28	-28	-0630S	-381
FC659-20	-8S	-22	-8S	-28		-32			
FC693-04	-1S	-8	-13S	-2		-12	-12	0622S	
FC693-06	-1S	-10	-2S	-4		-16	-16	-0622S	
FC693-08	-3S	-12	-3S	-5		-18	-18	-0622S	
FC699-04	-12S	-6	-1S	-2		-12	-12	-0622S	
FC699-06	-14S	-10	-2S	-4		-16	-16	-0622S	-174
FC699-08	-3S	-12	-3S	-5		-16	-16	-0630S	-205
FC699-10	-4S	-12	-4S	-6		-20	-18	-0630S	-239
FC699-12	-5S	-16	-5S	-8		-20	-22	-0630S	-280
FC735-16	-7S	-22	-7S	-10	222005-15C	-24	-28	-0648S	-357
FC736-06	-3S	-12	-3S	-5		-16	-16	-0630S	-205
FC736-08	-4S	-12	-4S	-6		-20	-18	-0630S	-239
FC736-10	-5S	-16	-5S	-8		-20	-20	-0630S	-280
FC736-12	-6S	-16	-6S	-24		-24	-26	-0630S	-300

*Sizes indicated are based on Hose O.D. only. If sleeve is to be placed over fittings, a larger sleeve size may be required, depending on type of fitting used.

Accessories to Hose Chart

Part #	Steel Prot. Coil Spring* 900564 (dash size)	Plastic Coil Sleeve 900952 (dash size)	Steel Prot. Coil Sleeve* 900705 (dash size)	Support Clamp 900729 (dash size)	Internal Support Coil	Nylon Sleeve* FC425 (dash size)	Firesleeve* 624 (dash size)	Firesleeve Clamp FF9217 (dash size)	Heavy Duty Support Clamp FF9031 (dash size)
FC736-16	-7S	-22	-7S	-11		-28	-28	-0630S	-381
FC736-20	-8S	-22	-8S	-28		-32	-30	-0648S	
GH120-4	-1S	-8	-13S	-2		-12	-12	-0622S	-137
GH120-6	-2S	-10	-2S	-3		-16	-16	-0622S	-171
GH120-8	-14S	-12	-3S	-5		-16	-18	-0622S	-205
GH120-10	-54S	-16	-5S	-6		-20	-20	-0630S	-239
GH120-12	-5S	-16	-6S	-9		-22	-22	-0648S	-280
GH120-16	-7S	-22	-7S	-10		-24	-28	-0648S	-357
GH120-20	-9S	-30	-8S			-32	-30	-0648S	-422
GH120-24	-10S	-30	-15S	-29		-38	-38	-0648S	-508
GH120-32	-13S	-30	-12S	-30		-46	-46	-0664C	-635
GH194-4	-1S	-6	-1S	-1		-12	-11	-0622S	-137
GH194-6	-2S	-10	-2S	-3		-16	-14	-0622S	-174
GH194-8	-15S	-10	-3S	-5		-16	-16	-0622S	-205
GH194-12	-4S	-12	-4S	-6		-20	-18	-0633S	
GH194-10	-4S	-12	-4S	-6		-20	-18	-0630S	-239
GH194-12	-5S	-16	-5S	-8		-24	-22	-0648S	-280
GH194-16	-6S	-22	-6S	-25		-24	-26	-0648S	-357
GH194-20	-9S	-30	-8S	-1		-32	-30	-0648S	-445
GH195-4	-1S	-8	-13S	-2		-12	-12	-0622S	-150
GH195-6	-1S	-10	-2S	-4		-16	-16	-0622S	-190
GH195-8	-3S	-12	-3S	-5		-18	-18	-0622S	-222
GH195-10	-54S	-16	-5S	-6		-20	-20	-0630S	-266
GH195-12	-5S	-16	-6S	-9		-22	-22	-0648S	-300
GH195-16	-7S	-22	-9S	-10		-28	-28	-0648S	-381
GH195-20	-8S	-30	-10S	-12		-32	-32	-0664C	-483
GH195-24	-10S	-30	-11S	-13		-38	-38	-0648S	
GH195-32	-13S	-30	-12S	-30		-46	-46	-0664C	-635
GH466-20	-8S	-30	-8S	-13		-38	-38	-0648S	-508
GH493-6	-15S	-12	-3S	-5		-16	-16	-0622S	-205
GH493-8	-3S	-12	-4S	-6		-20	-20	-0648S	-239
GH493-10	-4S	-16	-5S	-8		-20	-22	-0648S	-280
GH493-12	-5S	-16	-6S	-27		-24	-24	-0648S	-300
GH493-16	-7S	-22	-7S	-10		-28	-28	-0648S	-381
GH493-20	-8S	-22	-10S	-28		-32	-38	-0648S	
GH493-24	-8S	-30	-10S	-29		-38	-38	-0648S	
GH493-32	-13S	-30	-11S	-31		-46	-46	-0664S	
GH506-12	-6S	-16	-6S	-24		-24	-26	-0648S	-320
GH506-16	-7S	-22	-7S	-10		-28	-30	-0648S	-381
GH506-20	-8S	-22	-9S	-28		-32	-32	-0648S	-445
GH663-4	-1S	-6	-1S	-1		-12	-11	-0622S	-137
GH663-6	-2S	-10	-2S	-3		-16	-14	-0622S	-174
GH663-8	-15S	-10	-3S	-5		-16	-16	-0622S	-205
GH663-12	-5S	-16	-5S	-8		-24	-22	-0648S	-280
GH663-16	-7S	-22	-6S	-25		-24	-26	-0648S	-357
GH663-20	-9S	-30	-8S	-12		-32	-30	-0648S	-422
GH663-24	-8S	-30	-8S	-13		-38	-38	-0648S	-483
GH663-32	-13S	-30	-12S	-30		-46	-46	-0664C	-635
GH681-4	-1S	-6	-1S	-1		-12	-11	-0622S	-127
GH681-6	-12S	-10	-2S	-21		-16	-14	-0622S	-160
GH681-8	-14S	-12	-3S	-4		-16	-16	-0622S	-205
GH781-4	-1S	-8	-13S	-2		-12	-12	-0622S	-137

*Sizes indicated are based on Hose O.D. only. If sleeve is to be placed over fittings, a larger sleeve size may be required, depending on type of fitting used.

Accessories to Hose Chart

Part #	Steel Prot. Coil Spring* 900564 (dash size)	Plastic Coil Sleeve 900952 (dash size)	Steel Prot. Coil Sleeve* 900705 (dash size)	Support Clamp 900729 (dash size)	Internal Support Coil	Nylon Sleeve* FC425 (dash size)	Firesleeve* 624 (dash size)	Firesleeve Clamp FF9217 (dash size)	Heavy Duty Support Clamp FF9031 (dash size)
GH781-6	-2S	-10	-2S	-3		-16	-16	-0622S	-174
GH781-8	-14S	-12	-3S	-5		-16	-18	-0622S	-205
GH781-10	-4S	-12	-5S	-6		-20	-18	-0630S	-239
GH781-12	-5S	-16	-14S	-9		-24	-22	-0648S	-280
GH781-16	-7S	-22	-7S	-10		-24	-28	-0648S	-357
GH781-20	-7S	-22	-9S	-12		-28	-28	-0648S	-422
GH781-24	-8S	-30	-8S	-13		-38	-38	-0648S	-508
GH781-32	-13S	-30	-12S	-30		-46	-46	-0664C	-635
GH793-4	-1S	-8	-13S	-2		-12	-12	-0622S	-150
GH793-6	-15S	-10	-2S	-4		-16	-16	-0622S	-190
GH793-8	-3S	-12	-3S	-5		-16	-18	-0622S	-222
GH793-10	-4S	-16	-5S	-6		-20	-20	-0630S	-266
GH793-12	-5S	-16	-6S	-9		-20	-22	-0648S	-300
GH793-16	-7S	-22	-9S	-10		-24	-28	-0648S	-381
GH793-20	-8S	-30	-10S	-12		-32	-32	-0664C	-483
GH793-24	-10S	-30	-10S	-13		-38	-38	-0648S	
GH793-32	-13S	-30	-12S	-30		-46	-46	-0664C	-635

*Sizes indicated are based on Hose O.D. only. If sleeve is to be placed over fittings, a larger sleeve size may be required, depending on type of fitting used.

SPECIALTY & TRUCK HOSE

LOW & MEDIUM PRESSURE HOSE

HIGH PRESSURE HOSE

HOSE FITTINGS

ADAPTERS & TUBE FITTINGS

ACCESSORIES & ASSEMBLY INSTRUCTIONS

HOSE ASSEMBLY EQUIPMENT

APPENDICES

Assembly Instructions

How to Braze Lifesaver Reusable Fittings

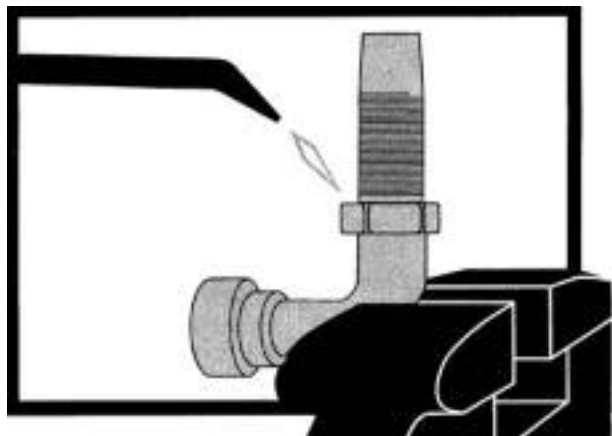

Materials needed:

- Eaton FF9705 silver braze rings or 1/16" diameter 45% silver alloy braze wire
- Water-soluble flux
- Brazing outfit capable of +1200°F (propane or mapp gas)
- Small files – rattail and flat
- Spray paint (quick drying)
- Water (to cool joint)
- Needle-nose pliers
- Tape measure
- Emery paper
- Hacksaw
- Pliers
- Pair of diagonals (or other tool to cut silver wire)
- Residue-free degreasing agent
- Wire brush



Brazing and assembling Lifesaver reusable fittings is a simple process

Eaton Lifesaver reusable hose fittings are designed to simplify the replacement of failed hose lines which have unusual, steel, end configurations or thread styles. The process involves removing the old tube configuration, silver brazing it to an unused lifesaver nipple and assembling the fitting onto the hose in the usual manner. A few Lifesaver fittings, some bulk hose, the appropriate hand tools and accessories plus basic silver brazing equipment are all that is necessary to make up hose assemblies anywhere. Be sure to follow all applicable safety procedures when making Lifesaver fittings.

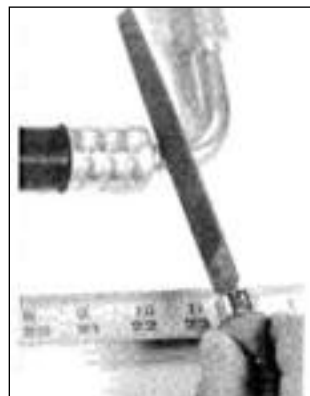

Step 1: Measuring

Measure and record the length of the old assembly. For elbow assemblies, scribe a very light mark 5/16" or more from the existing hose socket. The distance from the scribe mark to the end of the other fitting should be recorded as the fabrication length. In the case of double elbows, make the scribe marks in line with one another so that you can duplicate the phase angle later on. Record the distance between the two scribe marks as the fabrication length.

Step 2: Cutting

Using a hacksaw or tubing cutter, cut the tube at the juncture of the tube and the hose socket. It is important to cut the tube so there is at least a 1/4" length of straight, unbent tubing in order for it to properly enter into the counterbore of the Lifesaver nipple.

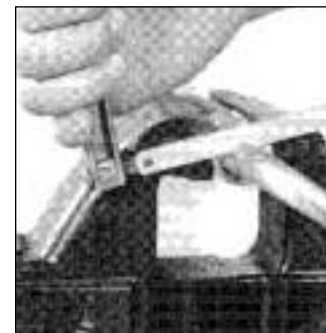

Step 3: Preparing the tube for brazing

Avoid touching the tube — oily or greasy surfaces tend to repel the flux and silver material leaving voids and inclusions. Clean the tube thoroughly using a residue-free degreasing agent or hot caustic soda.

Using a flat file, remove the burrs on the outside of the tube and use a rat tail file to remove the burrs on the inside.

Polish the end of the tube on the outside with an emery cloth to remove the plating down to the base metal. It is important to remove oil and grease first because abrasives tend to scrub the oil into the surface and/or impregnate it with a fine abrasive powder, resulting in further contamination. Remember, attempting to braze contaminated or improperly cleaned surfaces will generally result in an unsatisfactory joint!

Continued on next page.



Step 4: Preparing the Lifesaver fitting for brazing

Clean the nipple and tube end thoroughly. Place the tube into the counterbore (it should fit freely into it). Measure the diameter of the counterbore to determine the braze ring size needed. At this point, you have the option of selecting a ready-made Eaton braze ring or making a ring for the application from bulk silver braze wire.

For quick, easy assembly, Eaton offers the following size range of FF9075 braze rings:

PART NUMBER	TUBE SIZE O.D.	
	mm	in.
FF9075-19	6,4	.25
FF9075-06	9,7	.38
FF9075-74	12,7	.50
FF9075-08	16,0	.63
FF9075-09	19,1	.75
FF9075-86	25,4	1.00
FF9075-87	31,8	1.25
FF9075-88	38,1	1.50

To assemble, simply place the appropriate size Eaton FF9075 braze ring into the counterbore of the Lifesaver nipple.

To make the braze ring, multiply the diameter of the counterbore by 3 to determine the length of silver wire needed. For example, if the counterbore diameter measures $\frac{3}{4}$ of an inch, a $2\frac{1}{4}$ - inch length of wire would be needed ($\frac{3}{4} \times 3 = \frac{9}{4}$ or $2\frac{1}{4}$). Now cut off a piece of silver wire just short of $2\frac{1}{4}$ inches, so it is about $2\frac{3}{16}$ inches long. Using needle nose pliers, form the wire into a ring and, after wiping it off, place the ring into the counterbore of the Lifesaver nipple.



Step 5: Fluxing

Cover the counterbore, ring, outer hex and threads of the Lifesaver nipple and the outside of the tube with water soluble flux.



Step 6: Brazing

Place the tube assembly into a vise. Place the nipple with its braze ring over the tube. Light the brazing torch and adjust the flame so that the base is blue with orange "feather-like flicks" at the end. Try to heat both the nipple and the tube uniformly so they both reach the brazing temperature at the same time. Don't overheat the thin section. As the temperature increases, the flux will undergo several changes:

- At 212°F the water boils off.
- At 600°F the flux becomes white and puffy and starts to "work" (snow balling).
- At 800°F it lays against the surface and has a milky appearance.
- At 1100°F it is completely clear and active and has the appearance of water. At this point, a bright metal surface will be apparent underneath.
- The silver wire melts at 1125°F and flows at 1145°F.

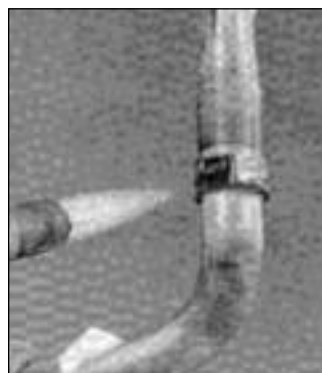

! CAUTION

Never heat the parts to a bright red color.

When the silver alloy melts, the flux will draw it throughout the joint and a small fillet of silver alloy will appear around the tube. When this happens, the braze is completed. Remove the heat source and allow the fitting to cool for five to ten seconds. Using pliers, place the fitting into water until it is completely cool.

! CAUTION

Steam may be directed through the fitting ends. To prevent burns, handle the fitting carefully! Hot water will facilitate flux removal.



Step 7: Removing flux

It is necessary to remove residual flux from the area since it is corrosive and presents an unclean appearance and condition. Simply rub the surface using hot water and a wire brush. The water should be at least 120°F or hotter to be truly effective inside and out.

Step 8: Hose assembly

To determine the required amount of new hose, measure the distance from the scribe mark on the tube (refer to Step 1) to the shoulder hex of the Lifesaver nipple. Add this measurement to the Lifesaver "D" dimension found in the "Fittings" section of the Eaton Hose & Reusable Fittings Catalog. For each Lifesaver fitting, subtract this sum from the fabrication length previously recorded. When using Eaton fittings other than the Lifesaver type, subtract the appropriate "D" dimension found in the catalog. Cut the hose to this length and install both fittings.

Align the scribe marks to establish the phase angle. Spray paint the brazed joints to prevent rusting.

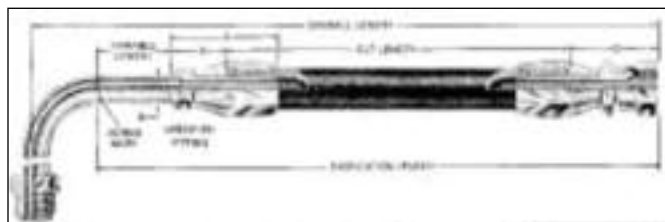

Assembly Instructions

ORS-TF (Wedge Type)

Tube Fittings

1. Measure the length of the tube assembly from the flat face of the ORS adapter in one port to the face of the ORS adapter in the opposite port. The length of the tube should then be adjusted to account for the shoulder thickness of the sleeve.

It is imperative that the routing leave a length of unbent tubing to fully enter the ORS fitting. This straight length must be free from surface defects, thin-out distortion, and ovality.

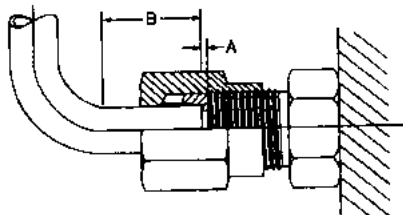

SIZE	TUBE O.D.	SLEEVE SHOULDER THICKNESS "A"		STRAIGHT TUBING REQUIRED "B"	
		mm	in.	mm	in.
-04	.25 (1/4)	1,8	.07	19,8	0.78
-06	.38 (3/8)	2,0	.08	22,3	0.88
-08	.50 (1/2)	2,3	.09	25,4	1.00
-10	.63 (5/8)	2,3	.09	26,9	1.06
-12	.75 (3/4)	2,3	.09	30,2	1.19
-16	1.00 (1)	2,3	.09	31,7	1.25
-20	1.25 (1 1/4)	2,3	.09	33,3	1.31
-24	1.50 (1 1/2)	2,3	.09	35,0	1.38

2. Inspect the tubing to insure that no scratches, gouges, burrs or other surface defects are present. Cut the measured tubing squarely ($\pm 1^\circ$). A tubing cutter is the best tool for this, but a hacksaw or abrasive wheel can be used. Use only SAEJ356, SAEJ524, SAEJ525, or SAEJ526 tubing with a hardness not to exceed Rockwell B65.



3. Deburr the tube ends with a deburring tool or fine cut file. After deburring, be sure to remove all contaminants and dirt from the interior and exterior of the tube.



4. Inspect ORS adapter and ORS-TF components for damage. Assure sealing surfaces are free from all surface gouges, scratches, dirt and contaminants. Inspect o-ring to insure that it is properly seated in the groove and is free from damage. Apply a thin film of compatible lubricant to the o-ring prior to installation.



5. Place a nut, ferrule and sleeve onto tubing, assuring that the identification groove of the ferrule is toward the nut. Assemble the nut to the adapter until "hand-tight" with the tubing fully inserted into the fitting until bottomed out. Mark the nut in relation with the adapter and tighten $1\frac{1}{2}$ turns with wrench. The ORS-TF sleeve cannot be used to preset multiple tube assemblies. It may be used once for presetting.



6. The ORS-TF tube assemblies are designed for re-use and can be re-installed by tightening nut until a sharp increase in resistance is felt (approximately $\frac{1}{4}$ turn beyond "hand-tight").

8. If connections must be temporarily disassembled, use a threaded plug to contain the ORS-TF components and keep contaminants and dirt from entering the system.

7. **WARNING**

Tubing must be fully inserted into the fitting and the nut tightened as specified above to ensure performance and to prevent leakage and potential fitting blow-off. Excessive tightening of the nut beyond the recommended level may affect performance.

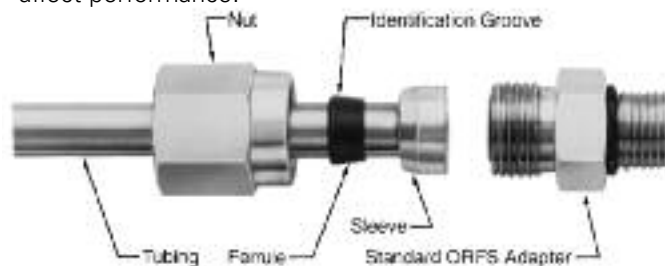

SPECIALTY & TRUCK HOSE

LOW & MEDIUM PRESSURE HOSE

HIGH PRESSURE HOSE

HOSE FITTINGS

ADAPTERS & TUBE FITTINGS

ACCESSORIES & ASSEMBLY INSTRUCTIONS

HOSE ASSEMBLY EQUIPMENT

APPENDICES

Brazing Instructions ORS-Braze Type Tube Fittings

Tube Preparation

1. Establish the required length of tubing. Allow for insertion depth in the ORS-Braze Type shoulder by adding the proper length of straight unbent tubing to enter into the shoulder counterbore. The counterbore depth is dependent upon the ORS-Braze Type shoulder size.



ORS-BRAZE TYPE SHOULDER SIZE	DEPTH OF COUNTERBORE	
	mm	in.
-04	6,3	.25
-06	6,3	.25
-08	9,6	.38
-10	9,6	.38
-12	9,6	.38
-16	12,7	.50
-20	12,7	.50
-24	12,7	.50

2. Cut the tubing squarely ($\pm 1^\circ$) to the proper length. A tubing cutter is the best tool for this, but a hacksaw or an abrasive wheel can be used.

3. Lightly deburr both I.D. and O.D. of tube.



Prepare the Tube

4. Clean the end of the tube thoroughly using a liquid solvent* such as denatured alcohol, alkaline cleaner or equivalent.

Avoid touching it because oily or greasy surfaces tend to repel the flux and silver material leaving voids and inclusions.

**CAUTION: Follow solvent manufacturer's recommendations for proper use. Follow approved procedures for disposal.*

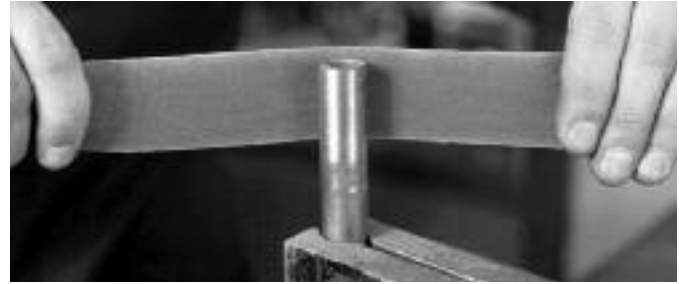

5. Polish tube end to bare metal using silicon carbide emery cloth. It is important to remove all oil and grease first because abrasives tend to scrub the oil into the surface and/or impregnate it with a fine

abrasive powder resulting in further contamination. Clean the tube end to remove the grit produced by the emery operation. Use either a clean solvent rinse or a clean, oil free soft cloth.

Prepare the Shoulder

6. Degrease the shoulder thoroughly. Inspect for presence of rust. If rust is present, follow the steps detailed previously to emery the counterbore.



Prepare Braze Rings

7. Degrease rings thoroughly. Preformed silver braze rings are available from Eaton. The preformed rings (Part Number FF9075-Size) will save you time and simplify your brazing even more.



If site-made rings are used, cut off a piece of silver wire* just short of three times the counterbore's diameter. For example, if the counterbore measured $\frac{3}{4}$ " you would cut $2\frac{1}{16}$ " of wire ($\frac{3}{4}$ " \times $2\pi r = 2\frac{1}{4}$ "). Use needle-nose pliers to shape the silver wire into a ring.

**If bulk wire is used it must contain a minimum of 45% silver content.*



Silver Braze Ring

PART NUMBER	TUBE SIZE O.D.	
	mm	in.
FF9075-19	6,4	.25
FF9075-06	9,7	.38
FF9075-74	12,7	.50
FF9075-08	16,0	.63
FF9075-09	19,1	.75
FF9075-86	25,4	1.00
FF9075-87	31,8	1.25
FF9075-88	38,1	1.50

Trial Assembly

8. Fit the shoulder onto the tube; it should fit freely for the full counterbore depth. Eaton recommends minimal diametrical clearance. Do not touch or contaminate mating surfaces.

Fluxing and Assembly



9. Clamp the tube snugly in a vise. Properly slip ORS-Braze Type nut (FC2326-SIZE-186) over the tube. The flux (high temperature 700°F to 1800°F is recommended) should be applied to all components and adjacent areas. This will minimize the heat scale formed, act as a temperature

10. Lightly flux ORS-Braze Type shoulder (FC1229-SIZE) counterbore, install clean braze ring to bottom of counterbore, reflux counterbore.

11. Slip shoulder onto tube squarely and so that braze ring is snug between the tube and counterbore lip.

12. Flux outside surfaces of shoulder.



indicator, and promote proper alloy flow during the brazing process.



14. Allow braze alloy to solidify completely before quenching. Cool the assembly in hot water (+180°F preferred) to help facilitate flux removal. Readily available flux removers can be added to the water. It is necessary to remove the flux residue because it is corrosive.



Braze Inspection

15. Inspect braze for a fillet all the way around the tube. Inspect the shoulder sealing surface. There should be no alloy overrun or alloy build-up on the sealing surface. An accumulation of braze alloy on the sealing surface or a void in the fillet is unacceptable and the shoulder should be replaced.



Brazing the Assembly



13. To properly braze the application of heat should bring both the tube and shoulder up to brazing temperature uniformly. Therefore, most of the heat should be directed to the shoulder and not the tube. The flux may be used as a guide:

- A. At +212°F the water boils off.
- B. At +600°F to +700°F the flux becomes puffy and starts to "work" (bubbles).
- C. At +800°F it lays against the surface and has a translucent appearance.
- D. At +1100°F it has the appearance of dark clear water.

16. It is recommended to proof test the assembly in an enclosed chamber. Proof test pressure should be twice the system's operating pressure but should not exceed twice the recommended operating pressure of the tube or end connections.

NOTE: The preceding procedure is recommended only. No guarantee or warranty is implied.



E. At +1125°F the silver braze ring melts and flows at +1145°F. At this point the shoulder should drop onto the tube a distance equal to the diameter of the braze ring, which is not melted and filling in the area between the counterbore and tube O.D. There should be visible braze material at both ends of the shoulder.

The braze joint area needs to be heated uniformly not just the O.D. surface. At brazing temperature the components will have a dark red to medium cherry red appearance. Do not overheat the parts as to char the flux. Remove the heat after the alloy has melted and pulled through the joint. Settle the shoulder onto the tube to insure proper insertion.

NOTE: The heating source should be varied. When using a flame, the fuel mixture should be adjusted so that the base of the flame is blue and there are also orange featherlike licks at the end of the flame.



SPECIALTY & TRUCK HOSE

LOW & MEDIUM PRESSURE HOSE

HIGH PRESSURE HOSE

HOSE FITTINGS

ADAPTERS & TUBE FITTINGS

ACCESSORIES & ASSEMBLY INSTRUCTIONS

HOSE ASSEMBLY EQUIPMENT

APPENDICES

Assembly Instructions for ORS Tube Fittings, Pipe Threads and SAE 37° (JIC) Flared Tube Fittings

Assembly Instruction for ORS Tube Fittings

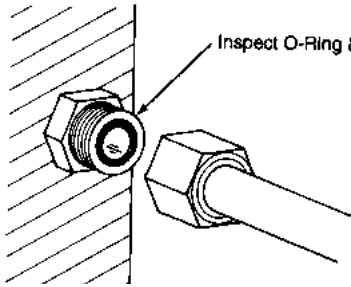

1. Inspect sealing surfaces and O-Ring groove for damage or foreign material. Check the O-Ring to insure that it is properly seated in the O-Ring groove.

3. Align the ORS Tube Fitting to the flat sealing connections and tighten the nut by hand. The nut should tighten easily by hand if properly aligned.

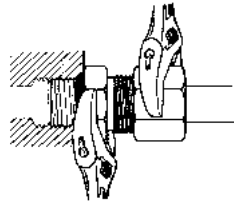

4. Complete the assembly by wrench tightening the nut to the recommended torque value on page 286.

Assembly Instructions for Pipe Threads

1. Assemble connection hand tight.
2. Mark male and female.
3. Rotate male; 1½ turns if using thread sealant. 2 turns if not using thread sealant.

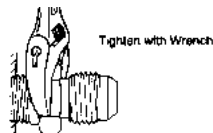
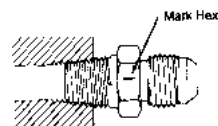
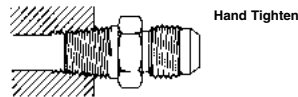

Assembly Instructions for Standard SAE 37° Flare Type Tube Fitting

Use SAE J524 or SAE J525 tubing for best bending and flaring results.

1. Cut the tubing with a tube cutter. If a fine tooth hacksaw is used, make sure cut-off is square; remove burrs with deburring tool, emery paper or fine file. Clean all dirt and grit from the I.D. and O.D. of the tube.
2. Place the nut and then the sleeve onto tube.
3. Flare the tube end with a flaring tool to provide a 37° flare. Check the flare for correct diameter, excessive thin out and burrs or cracks.

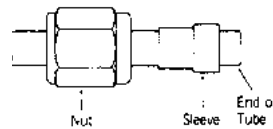

4. Lubricate all mating surfaces of nut, ferrule and body with a heavy lubricant such as Aeroquip 222070 Lube.
5. Assemble the nut and sleeve to body. Turn the nut hand tight then wrench tighten for a leakproof joint. See page 378, torque values, for assembly using a torque wrench.

The Eaton standard 37° flare fitting is easy to disassemble and may be reassembled repeatedly.

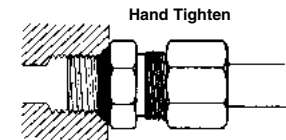
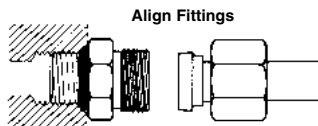
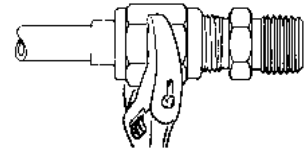

2. Lubricate threads with heavy lubricant such as Aeroquip 222070 Lube.

Assembly Instructions for Versil-Flare Tube Fittings

Cutting

To insure a leak-proof joint, the tubing should be cut square ($\pm 1^\circ$). A tube cutter is preferred, but a hacksaw or abrasive wheel can be used.



Deburring

All cut tubes should be deburred. However, deburring is even more important if the tubing was cut with a hacksaw or abrasive wheel. Remove any burrs, both internally and externally, with a deburring tool, emery paper or fine file. Clean the tube before assembly. Clean all dirt and grit from the I.D. and O.D. of the tube.

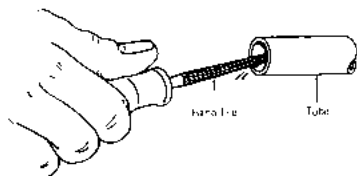

Assembly Instructions for Versil-Flare Tube Fitting

Tube cut-off

1. Tube should be cut to fit tight against the face of standard SAE 37° flare body.

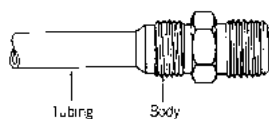

Initial assembly

1. Deburr the end internally and externally. Clean all dirt and grit from I.D. and O.D.
2. Slide the nut and then the ferrule into the tube. Make sure the tapered end of ferrule points toward the nut.

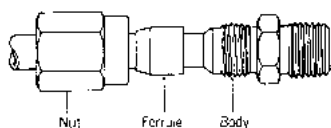

3. Lubricate all mating surfaces of nut, ferrule and body with a heavy lubricant such as Aeroquip 222070 Lube.
4. Place end of tube against standard SAE 37° flare body.

5. Slide the ferrule and nut against body and tighten the nut onto the body "Hand Tight." Mark the nut in relation to the body for location.

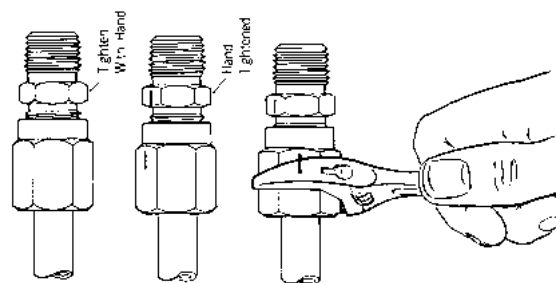

6. Hold tube against body and tighten nut a total of $1\frac{1}{4}$ turns on -3 through -10 and $1\frac{1}{2}$ turns -12 through -32.

Reassembly

1. Slide nut against the body and tighten to "Hand Tight." Mark the nut for location.
2. Tighten nut a minimum of one "Hex" flat. The Versil-Flare flareless tube fitting is designed for a maximum of 10 reassemblies.

Assembly Instructions – Adjustable O-Ring Boss

On SAE, and
BSPP threads without check washer

On BSPP
threads with check washer

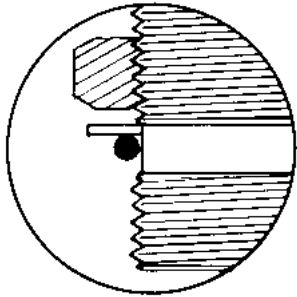
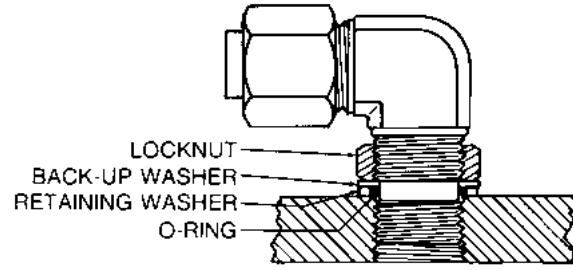
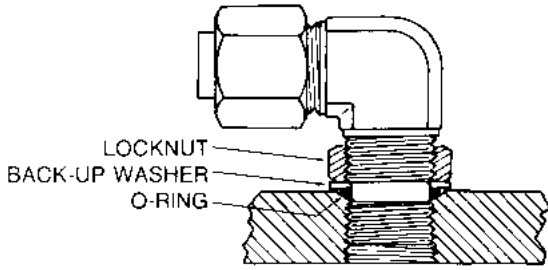

The o-ring and back-up washer should be in the proper position on non-threaded section nearest to locknut. Lubrication of the o-ring is recommended.

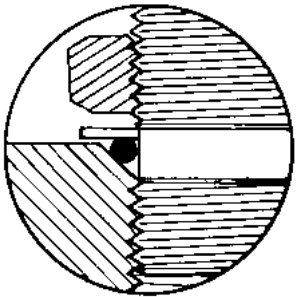
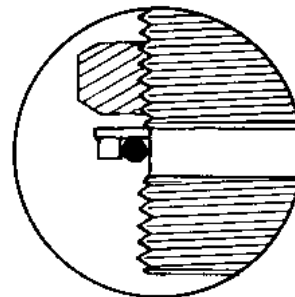

Tighten the fitting by hand into the straight threaded boss until back-up washer contacts face of boss (left) or check washer when thread is BSPP (right.)

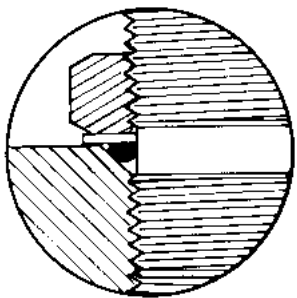
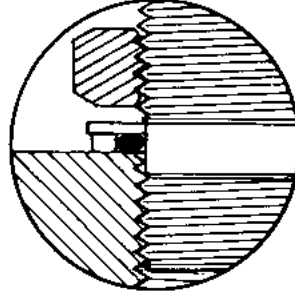

In order to position the fitting, unscrew up to one full turn then hold fitting in desired position and tighten locknut so that the back-up washer contacts face of boss and forces the o-ring within boss cavity. With BSPP threads use same procedure. The difference between the two thread types exist in the check washer being in contact with face of boss (right inset). Assemble to the respective assembly torque specified on page 378.

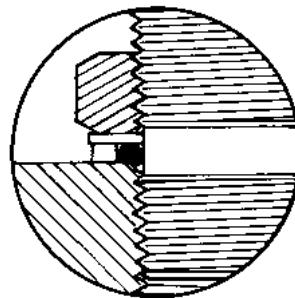

SPECIALTY & TRUCK HOSE
LOW & MEDIUM PRESSURE HOSE
HIGH PRESSURE HOSE
HOSE FITTINGS
ADAPTERS & TUBE FITTINGS
ACCESSORIES & ASSEMBLY INSTRUCTIONS
HOSE ASSEMBLY EQUIPMENT
APPENDICES

Terms

- *Skive*—Removal of the cover material exposing the reinforcement prior to fitting assembly.
- *Dash Size*—The hose or fitting size expressed in $\frac{1}{16}$ of an inch. The numerator of a fraction whose denominator is 16. Example: -8 or -08 is $\frac{8}{16}$ " = $\frac{1}{2}$ ".
- *Nipple*—The part of a hose fitting that goes into the hose tube.
- *Socket*—The part of a hose fitting that goes over the hose cover or reinforcement.
- *Mandrel*—A round, properly sized, steel bar used for support during assembly of the fitting or skiving the hose cover.
- *Annular Rings*—A series of concentric rings inside the socket.

Reusable fitting tips to remember for easy assembly

- Part numbers and dash sizes are indicated on fitting sockets.
- It is essential the fitting be mated with a compatible hose style with the same dash size. See Socket Data pages 63-65.
- Reusable fittings that have a notch in the socket serve as a reference for the cover skiving length.
- Familiarize yourself with the assembly instructions before you start to make an assembly.
- For hoses that require skiving, be sure to skive the hose to the proper length and **down to the wire reinforcement**.
- Use Aeroquip 222070 hose assembly lube liberally on both the inside of the hose and on the fitting nipple. (Check for compatibility.)
- Always cut hose square by using a sharp instrument (hacksaw or cutoff wheel).
- For volume production of hose assemblies, use Eaton Assembly Equipment.

Cutting the hose

1. To determine the "J" length (cut length of hose) from "OA" (overall length) deduct "D" dimensions of both end fittings. Consult fitting information pages for "D" dimensions. For hose assemblies with SOCKETLESS fittings, add $\frac{1}{2}$ " to "J" length. **Tip: If the old Aeroquip assembly was the right length, simply remove the hose fittings and measure the hose.**
2. Cut the hose square. Use a cut-off wheel or fine-tooth hacksaw.
3. Clean the hose bore. Blow out shavings with shop air, blow a foam projectile through the hose using the JetCleaner System (see page 296) or flush with a solvent compatible with the hose construction.



CAUTION
Follow proper safety procedures.

Phase angle (offset)

When making double elbow assemblies, the following steps should be followed to obtain the desired angle between elbows. Tighten both elbows to maximum allowable gap between socket and nipple hex. Start to position for relative angle between elbows. Finish assembly by adjusting both elbows. Backing off to get desired angle should be avoided.

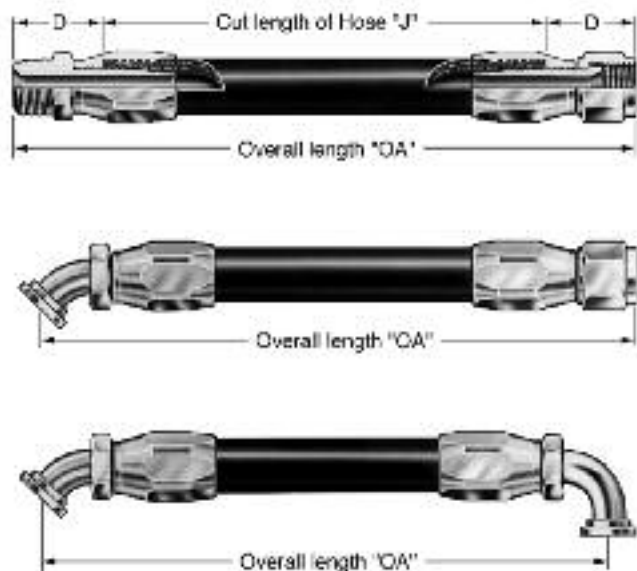
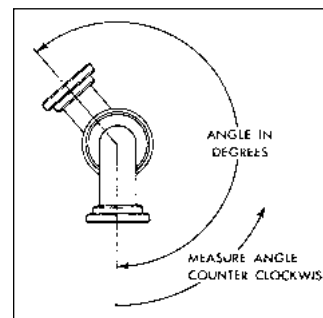

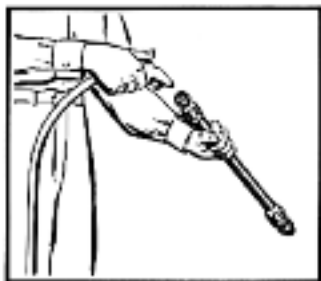

Clean



Inspect

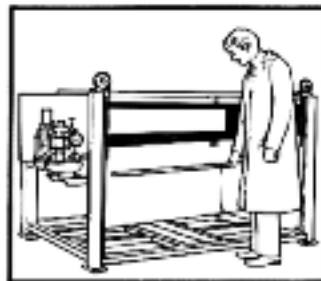

Proof test - hydrostatic

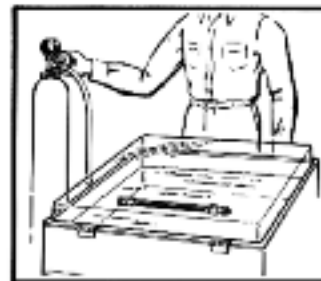

Proof test - pneumatic

Maintenance

Hose assemblies in operation should be inspected frequently for leakage, kinking, abrasion, corrosion or any other signs of wear or damage. Worn or damaged hose assemblies should be replaced immediately.

Clean

At minimum a hose assembly should be blown out with clean compressed air. Eaton recommends using the Jetcleaner Hose Cleaning System (See page 296 for details). Assemblies may be rinsed out with mineral spirits if the tube stock is compatible with oil, otherwise hot water at +150°F max. may be used. Consult Eaton for special cleaning equipment.

Inspect

Examine hose assembly internally for cut or bulged tube, obstructions, and cleanliness. For segment style fittings, be sure that the hose butts up against the nipple shoulder; band and retaining ring are properly set and tight, and segments are properly spaced. Check for proper gap between nut and socket or hex and socket. Nuts should swivel freely. Cap the ends of the hose with plastic covers to keep clean.

Proof test - hydrostatic

The hose assembly should be hydrostatically tested at twice the recommended working pressure of the hose.

Test pressure should be held for not more than one minute and not less than 30 seconds. When test pressure is reached, visually inspect hose assembly for: a) Any leaks or signs of weakness. b) Any movement of the hose fitting in relation to the hose. Any of these defects are cause for rejection.

Caution: Testing should be conducted in approved test stands with adequate guards to protect the operator.

(See Assembly Equipment Section for Eaton Proof Test Stands.)

Proof test - pneumatic

Hose assemblies intended for gas or air service should be tested with air or nitrogen at 100 psi with the assembly immersed in water. Random bubbles may appear over the hose and fitting area when assembly is first pressurized. This should not be construed as a defect. However, if the bubbles persist in forming at a steady rate at any particular point on the hose, the assembly should be rejected.

Caution: Testing should be conducted in approved test stands with adequate guards to protect the operator.

Storage and handling

Hose should be stored in a dark, dry atmosphere away from electrical equipment, and the temperature should not exceed +90°F. Storage in the original shipping container is preferred.

Standard (mandrelless) reusable fittings with single wire braid, multiple textile braid, hydraulic and LPG hose.

FC234, FC300, FC321, FC350, FC355, 302A, 303, 1503, 2580, 2651

(for fittings requiring mandrel, see page 324).

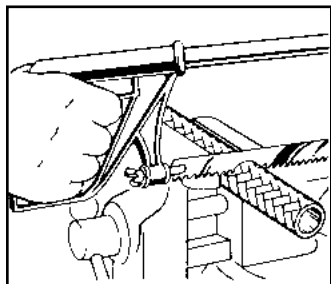

Step 1

Cut hose square with fine-tooth hacksaw or cut-off wheel.

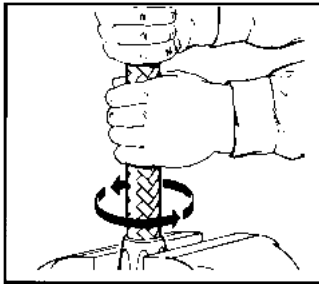

Step 2

Put socket in vise. Screw hose counterclockwise into socket until it bottoms. Back off 1/4 turn.

When assembling long lengths of hose, it may be preferred to put hose in vise just tight enough to prevent from turning, and screw socket into the hose counterclockwise until it bottoms.

Back off 1/4 turn. Back off FC300, FC350 and FC355 1/4 to 1/2 turn.

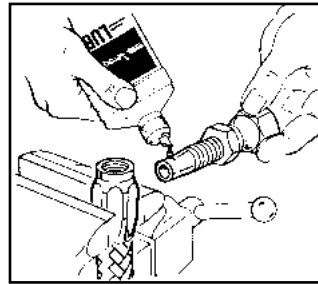

Step 3

Lubricate nipple and threads LIBERALLY. Use heavy oil or Aeroquip 222070 hose assembly lube.

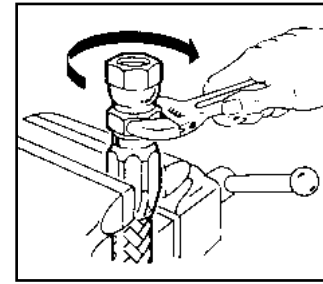

Step 4

Screw nipple clockwise into socket and hose. Leave 1/32" to 1/16" clearance between nipple hex and socket.

Recommendations for cleaning, inspection and testing are summarized on page 318. Disassemble in reverse order.

SOCKETLESS Fittings with textile braid low pressure hose

FC332, FC647, 2556, 2565, 2575

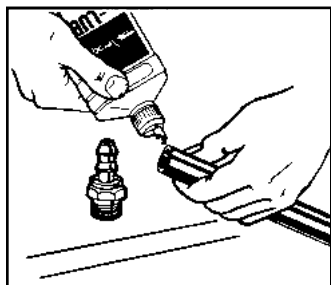

To Assemble

Step 1

Cut hose to required length with a sharp knife. Oil inside of hose and outside of nipple LIBERALLY.

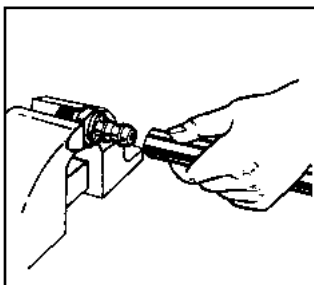

Step 2

Push hose on fitting until hose end bottoms underneath protective cap as shown. For quantity production use a SOCKETLESS Fitting assembly machine. Recommendations for cleaning, inspection and testing are summarized on page 318.

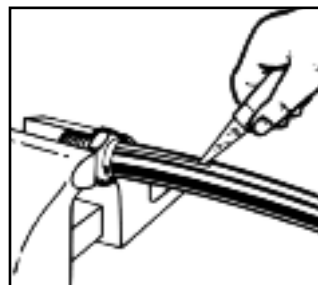

To Disassemble

Step 1

Slit hose lengthwise from protective cap to end of nipple.

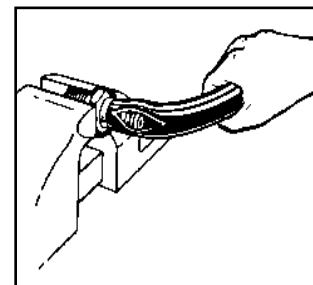

Step 2

Bend hose, then snap hose off with a quick tug.

Standard reusable fittings with Hi-Pac and two wire braid hose FC195, FC310, FC510, 2766, 2781

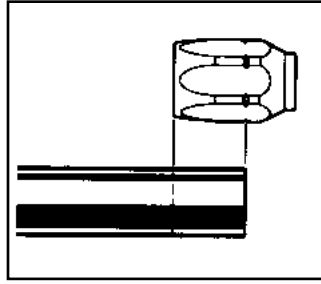

Step 1

Cut hose to length required using a fine-tooth hacksaw or cut-off wheel. Clean hose bore.

Hose must be stripped of its rubber cover before inserting in socket. Locate skiving point by putting hose end next to socket as shown. Measure from hose end of socket to notch on socket.

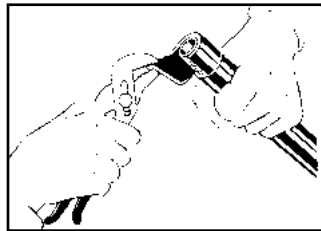

Step 1A

Skive Hose:

By Hand: Cut rubber cover around down to wire reinforcement. Slit lengthwise. Raise flap and pull off with pliers. Clean excess rubber off wire reinforcement with wire brush or soft wire wheel. Do not fray or flare wire reinforcement when brushing.

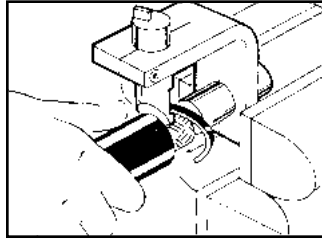

Skive Tool: Use the correct size FT1229 hose cover skiving tool. Mount the tool in a vise. Push the hose over the mandrel. Rotate the hose clockwise until it bottoms or secure hose in a vise and attach FT1279 auger to the skive tool. Insert mandrel into the hose and rotate clockwise until it bottoms.

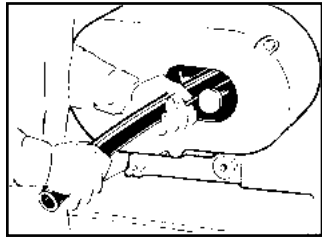

Machine: Use the S1102 cut-off and skiving machine. Consult the owners manual. Select the correct mandrel. Turn on the machine. Put the hose over the mandrel and rotate.

Note: when skiving, remove the rubber cover until the wire reinforcement is exposed around the circumference of the hose.

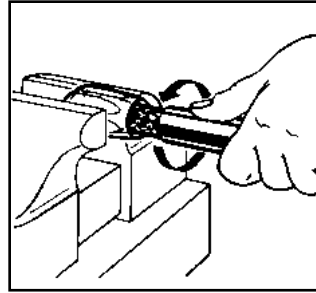

Step 2

Put socket in vise.

Screw hose into socket counterclockwise until it bottoms.

When assembling long lengths of hose, it may be preferred to put hose in vise just tight enough to prevent from turning, and screw socket onto the hose counterclockwise until it bottoms.

NOTE: Sockets for hose fittings in the -16, -24 and -32 sizes are furnished with internal annular grooves in place of helical grooves (all FC310 and FC510 hose sockets are annular grooved). Install socket by pushing hose into socket with a back and forth rocking and twisting motion until hose bottoms on shoulder of socket.

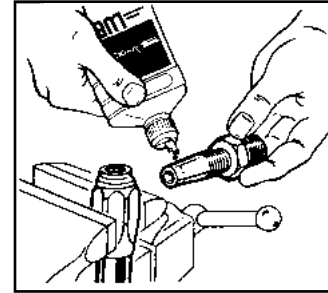

Step 3

Lubricate nipple threads and inside of hose liberally. Use heavy oil or Aeroquip 222070 hose assembly lube.

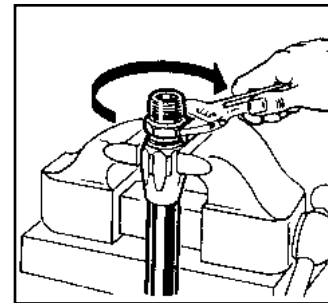

Step 4

Screw nipple clockwise into socket and hose.

Leave 1/32" to 1/16" clearance between nipple hex and socket.

Recommendations for cleaning, inspection and testing are summarized on page 318. Disassemble in reverse order.

Standard reusable fittings with four spiral wire hose

FC324, GH493, FC736

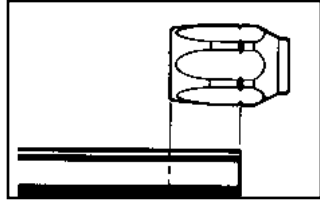

Step 1

Cut hose to length required using a fine-tooth hacksaw or cut-off wheel. Clean hose bore.

Hose must be stripped of its rubber cover before inserting into socket. Locate skiving point by putting hose end next to socket as shown. Measure from hose end of socket to notch on socket.

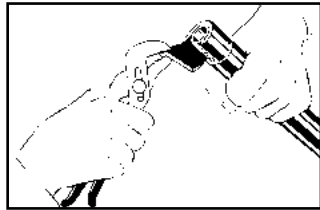

Step 1A

Skive Hose

By Hand: Cut rubber cover around down to wire reinforcement with a knife. Slit lengthwise. Raise flap and pull off with pliers. Clean excess rubber off wire reinforcement with wire brush or soft wire wheel. Do not fray or flare wire reinforcement when brushing.

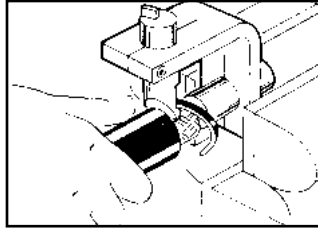

Skive Tool: Use the correct size Eaton FT1229 hose cover skiving tool. Mount the tool in a vise. Push the hose over the mandrel. Rotate the hose clockwise until it bottoms or secure hose in a vise and attach FT1279 auger to the skive tool. Insert mandrel into the hose and rotate clockwise

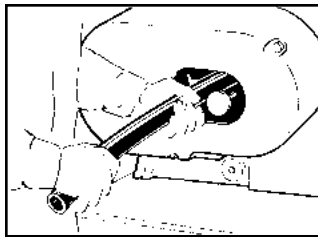

until it bottoms.

Machine: Use the Eaton S1102 cut-off and skiving machine. Consult the owners manual. Select the correct mandrel. Turn on the machine. Put the hose over the mandrel and rotate counterclockwise.

Note: when skiving, remove the rubber cover until the wire reinforcement is exposed around the circumference of the hose.

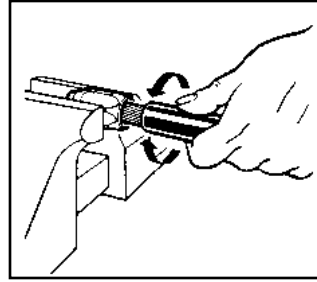

Step 2

Sockets for hose fittings are furnished with internal annular grooved design. Install socket by pushing hose into socket with a back and forth rocking and clockwise twisting motion until hose bottoms on shoulder of socket.

An alternate method is to insert the hose in a vise. Install socket by pushing onto the hose with a back and forth rocking and clockwise twisting motion until the hose bottoms on the shoulder of socket.

A rawhide hammer or similar tool may be used to tap the socket onto the hose but avoid damage to internal socket threads. Be sure not to damage hose cover or wire reinforcement.

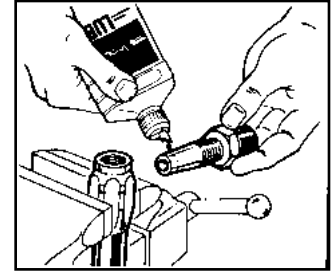

Step 3

Liberaly lubricate nipple threads and inside of hose. Use heavy weight oil or Aeroquip 222070 hose assembly lube.

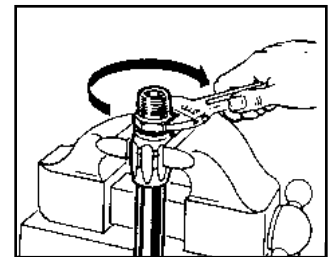

Step 4

Screw nipple clockwise into socket and hose. Leave a $\frac{1}{32}$ " to $\frac{1}{16}$ " clearance between nipple hex and socket.

Recommendations for cleaning, inspection and testing are summarized on page 318. Disassemble in reverse order.

Thru-the-cover style reusable fittings with hose

FC211, FC212, GH663, GH793

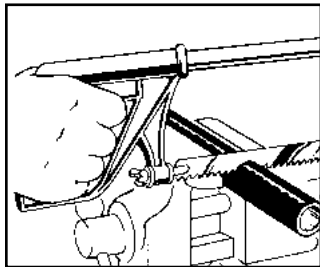

Step 1

Cut hose to length required using a fine tooth hacksaw or cut-off machine. Clean hose bore.

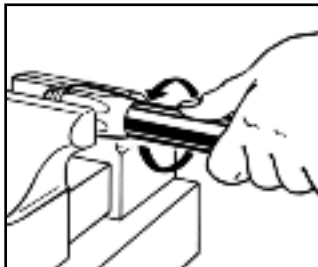

Step 2

Liberaly lubricate hose cover with Aeroquip 222070 hose assembly lube.

Place socket in vise and turn hose into socket counterclockwise until it bottoms.

When assembling long lengths of hose, it may be preferred to put hose in vise just tight enough to prevent from turning, and screw socket onto the hose counterclockwise until it bottoms.

Step 3

Liberaly lubricate nipple threads and inside of hose. Use heavy weight oil or Aeroquip 222070 hose assembly lube.

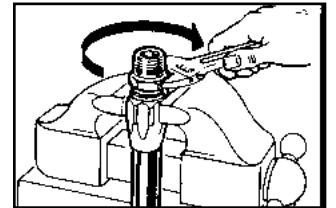

Step 4

Screw nipple clockwise into socket and hose. Leave $\frac{1}{32}$ " to $\frac{1}{16}$ " clearance between nipple hex and socket.

Recommendations for cleaning, inspection and testing are summarized on page 318. Disassemble in reverse order.

Standard (mandrelless) reusable fittings with engine, air brake and railroad air brake hose 1531, 1531A, 2550, 2554, 2570 (for fittings requiring mandrel, see page 324)

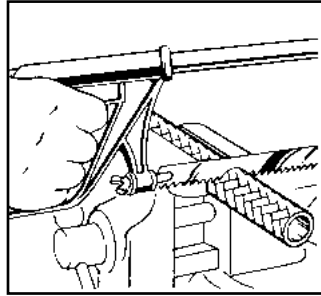

Step 1

Cut hose square to length required with fine-tooth hacksaw or cut-off wheel. Clean hose bore.

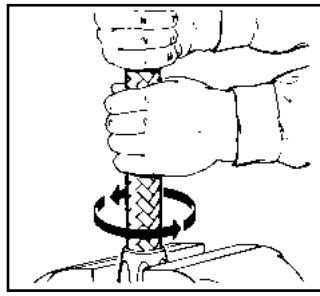

Step 2

Put socket in vise. Screw hose counterclockwise into socket until hose bottoms. Back off $\frac{1}{4}$ turn.

When assembling long lengths of hose, it may be preferred to put hose in vise just tight enough to prevent from turning, and screw socket into the hose counterclockwise until it bottoms. Back off $\frac{1}{4}$ turn.

NOTE: For 2550, 2554 and 2570 hose: Sockets for these hose fittings are furnished with internal annular grooved design. Install socket by pushing hose into socket with a back and forth rocking and twisting motion until hose bottoms on shoulder of socket. Back off $\frac{1}{4}$ turn.

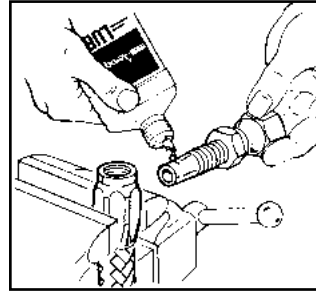

Step 3

Lubricate nipple threads and inside of hose LIBERALLY with Aeroquip 222070 hose assembly lube or heavy weight oil.

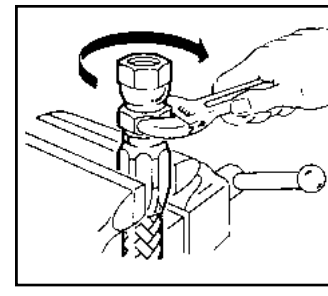

Step 4

Screw nipple clockwise into socket and hose. Leave a $\frac{1}{32}$ " to $\frac{1}{16}$ " clearance between nipple hex and socket.

Recommendations for cleaning, inspection and testing are summarized on page 318. Disassemble in reverse order.

"super gem"® Fittings with PTFE hose

FC465, 2807, 2808

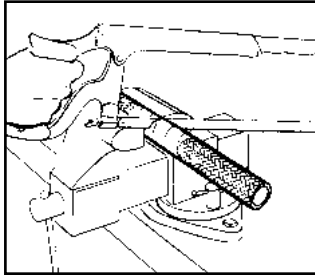

Step 1

Wrap hose with masking tape at cut-off point and cut square to length through taped area using a cut-off machine or fine-tooth hacksaw. Remove tape and trim any loose wires flush with tube stock. Any burrs on the bore of the tube stock should be removed with a knife. Clean the hose bore. Sometimes wire braid will tend to "neck down" on one end and flare out, on the opposite end. This is a characteristic of wire braid hose and can be used to an advantage in the assembly of the "super gem" sockets. Slip two sockets back to back over the "necked down" end of the hose.

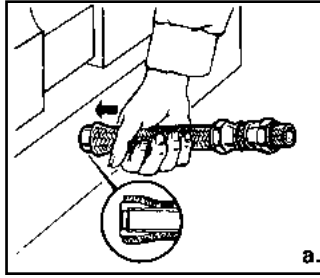

Step 2

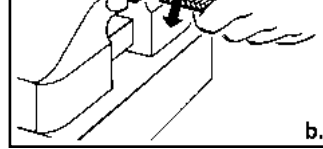

- a. Push the sleeve over the end of the tube and under the wire braid by hand. Complete positioning of the sleeve by pushing the hose end against a flat surface. Visually inspect to see that tube stock butts against the inside shoulder of the sleeve.
- b. Set the sleeve barbs into the PTFE tube by using assembly tool FT1038A or working the hose bore over the nipple into the end of the sleeve and tube. Assembly kit FT1081 is also available.

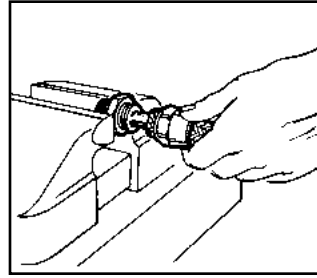

Step 3

Lubricate nipple and socket threads. For stainless steel fittings, use a molydisulfide base lubricant (e.g., Molykote® Type G), lubricants containing chloride are not recommended. Other material combinations use standard petroleum lubricants. Hold the nipple with hex in vise. Push hose over nipple with twisting motion until seated against nipple chamfer. Push socket forward and hand start threading of socket to nipple.

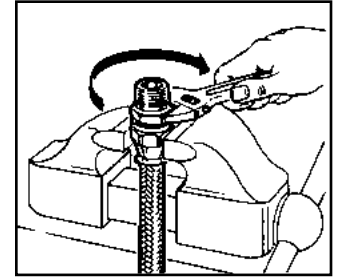

Step 4

Wrench tighten nipple hex until clearance with socket hex is $\frac{1}{32}$ " or less. Tighten further to align corners of nipple and socket hexes. Recommendations for cleaning, inspection and testing are summarized on page 318.

To disassemble: Unscrew and remove nipple; slide socket back on hose by tapping against flat surface; remove sleeve with pliers. New sleeves are recommended upon reuse of the fitting.

**Molykote Type G is a registered trademark of the Dow Corning Corporation.*

SPECIALTY &
TRUCK HOSE

LOW & MEDIUM
PRESSURE HOSE

HIGH PRESSURE HOSE

HOSE FITTINGS

ADAPTERS &
TUBE FITTINGS

ACCESSORIES &
ASSEMBLY INSTRUCTIONS

HOSE ASSEMBLY
EQUIPMENT

APPENDICES

Hose and Reusable Fittings

Mandrel Type Fittings—

Standard reusable fittings with single wire braid, multiple textile braid, hydraulic, LPG hose, engine and air brake hose
FC234, FC300, FC321, FC350, FC355, 302A, 303, 1503, 2580, 2651

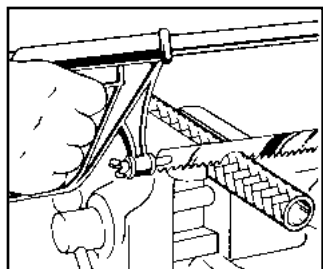

Step 1

Cut hose square with fine-tooth hacksaw or cut-off wheel. Clean hose bore.

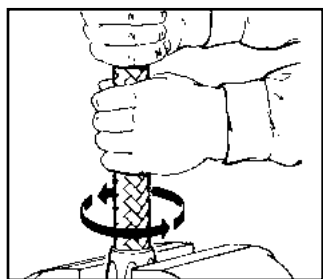

Step 2

Put socket in vise.

Screw hose counterclockwise into socket until it bottoms.

When assembling long lengths of hose, it may be preferred to put hose in vise just tight enough to prevent from turning, and screw socket onto the hose counterclockwise until it bottoms.

Back off $\frac{1}{4}$ turn.

Back off FC300, FC350 and FC355 hose $\frac{1}{4}$ to $\frac{1}{2}$ turn.

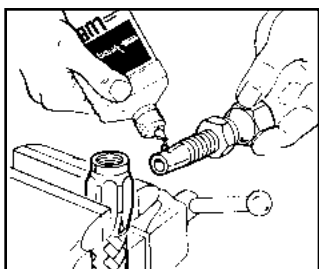

Step 3

MALE ENDS: Push assembly tool into nipple.
 SWIVEL ENDS: Tighten nipple and nut on assembly tool.

Lubricate nipple, mandrel and inside of hose liberally. Use heavy oil or Aeroquip 222070 hose assembly lube.

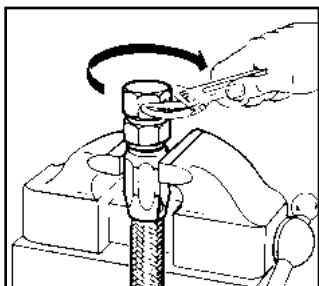

Step 4

MALE ENDS: Screw nipple clockwise into socket and hose. Leave a $\frac{1}{32}$ " to $\frac{1}{16}$ " clearance between nipple hex and socket.

SWIVEL ENDS: Screw nipple clockwise into socket and hose. Leave $\frac{1}{32}$ " to $\frac{1}{16}$ " clearance between nut and socket.

Recommendations for cleaning, inspection and testing are summarized on page 318. Disassemble in reverse order.

Nipple and clamp with suction hose

2661, FC619

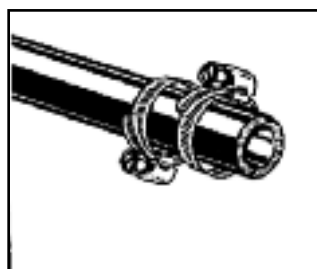

Step 1

Cut hose square to length required using a fine-tooth hacksaw or cut-off wheel. Clean hose bore. Slide band clamp over hose cover.

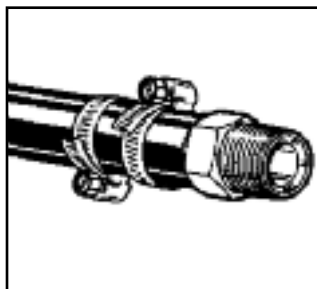

Step 2

Insert nipple into hose until hose end bottoms on nipple shoulder.

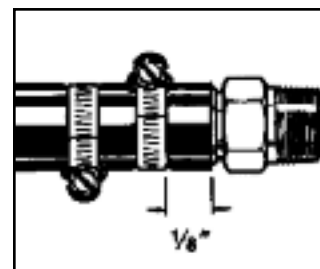

Step 3

Evenly space two band clamps from end of hose to end of nipple (see above). The band clamps should be tightened 180° from each other. Tighten clamps to 100 in-lbs. Recommendations for cleaning, inspection and testing are summarized on page 318.

**Silicone hose
FC252/FC352**

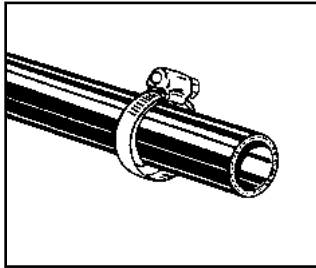

Step 1

Cut hose square to length required with a sharp knife. Slide extended hose clamp (FF9148) over hose cover.

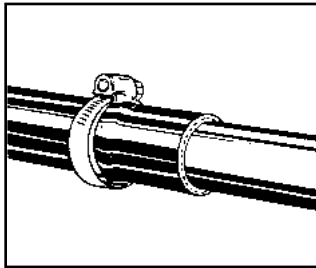

Step 2

Push hose over beaded tube.

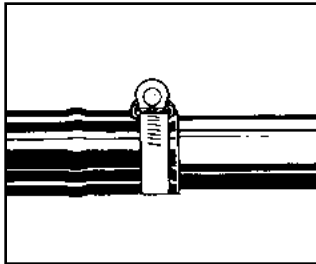

Step 3

Locate extended hose clamp (FF9148) near the end of hose and tighten the clamp.

Clamps: Extended hose clamps or clamps with a shoe are recommended for securing to formed and beaded male tube ends.

CAUTION: Do not use wire type clamps for securing silicone hose.

Note: Use of the FF9148 hose clamp will help prevent extrusion of the rubber cover through the clamp.

**900705 Steel protec-
tive coil sleeve**

**900564 Steel protec-
tive coil spring**

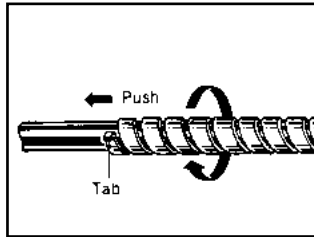

900705 sleeve

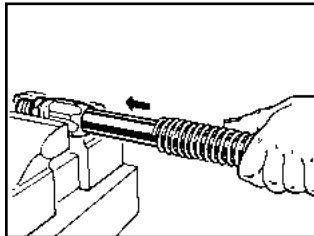

900564 spring

Step 1

Follow the appropriate assembly instructions through the assembly of one end fitting. Insert one end fitting in vise.

Step 2

Cut coil length. Coil should be cut to overall assembly length "OA" minus the sum of the overall length of each end fitting. ("A" dimension).

Step 3

3a) 900705 Steel Protective Coil Sleeve

The hose and the coil should be held straight. Taping or capping the hose end can prevent frayed wire ends from snagging on the coil. Bend one end to the coil outward to form a slight tab to assist grasping. (Cut off or bend back when installation is complete.) Hold the tab with the thumb of one hand while twisting the coil clockwise approximately one foot back from the coil tab. When the coil opens up sufficiently, slip the tab end to the coil over the hose. Move the coil onto the hose by pulling at the tab end while pushing with the other hand. Be careful not to exceed the resiliency of the coil by stretching it too far.

3b) 900564 Steel Protective Coil Spring

Slide coil over hose.

Step 4

Proceed with assembly of second end fitting.

**900952 Plastic coil
sleeve**

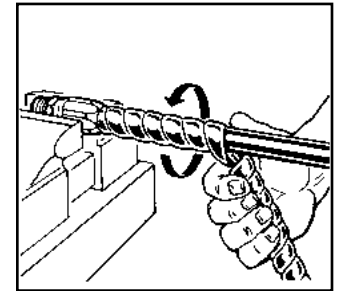

Step 1

Follow the appropriate hose assembly instructions through the assembly of both end fittings. Insert end fitting in vise.

Step 2

Cut coil length. Coil should be cut to overall assembly length "OA" minus the sum of the overall length of each end fitting. ("A" dimension).

Step 3

Wrap the coil on the hose.

Internal support coils

222005, 222022

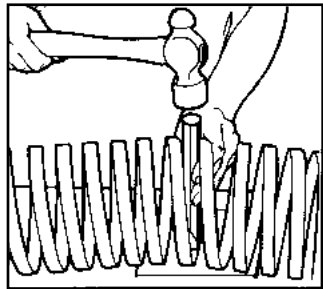

Step 1

Cut coil length. The coils should be cut to the hose length, minus the nipple intrusion. For any given hose assembly the support coil length equals the overall hose assembly length minus the sum of the overall lengths of each end fitting. ("A" dimensions.)

Small size of the coil can usually be cut with strap cutters or sheet metal shears. The larger sizes are best cut with a heavy sharp chisel or bolt cutter. With small sizes skip directly to Step 3.

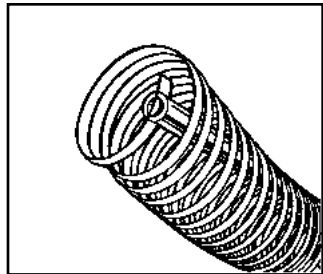

Step 2

Compress the coil (large sizes only). It is necessary to reduce the coil diameter slightly in order to insert it into the hose. The easiest approach is to use a length of pipe with a notch cut in one end. Clamp the plain end of the pipe in a vise, slide the coil over the pipe and insert the free end of the coil into the notched end of the pipe. Then clamp the coil and pipe firmly together. Twist the coil to compress it prior to installation into the hose.

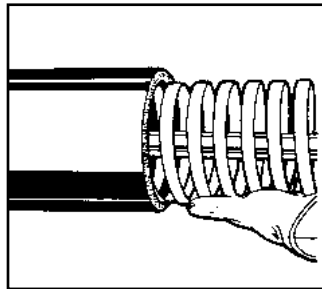

Step 3

Small sizes: The coil can be worked into the hose by hand without difficulty. Remove all burrs from the coil prior to insertion. This will prevent cutting of the hose tube. Position the coil midway between hose ends.

Large sizes: With the pipe still in position, as in Step 2, assemble the hose over the coil. With the coil fully centered in the hose, remove the pipe and clamp.

Firesleeve

624

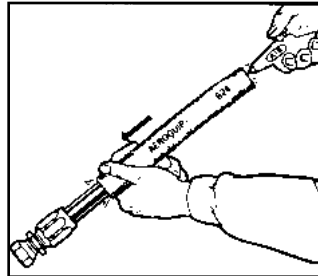

Step 1

Follow the appropriate hose assembly instructions through the assembly of one end fitting. Cut firesleeve to same length as hose; using Firesleeve End Dip (AE13702-003) dip ends of firesleeve to a depth of three quarters of an inch and allow to dry at room temperature.

Start firesleeve over cut end of hose. Note: If applying sleeve over PTFE or stripped cover assemblies, wrap exposed wire with tape. Grasp sleeve and slip over the hose assembly as illustrated.

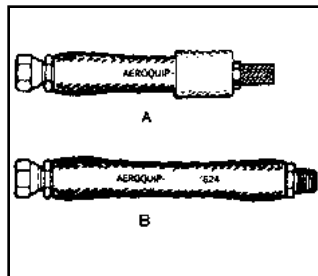

Step 2

Skin sleeve back from cut end of hose enough to allow assembly of second end fitting. (2A)

Then center sleeve so that it completely covers both sockets. (2B)

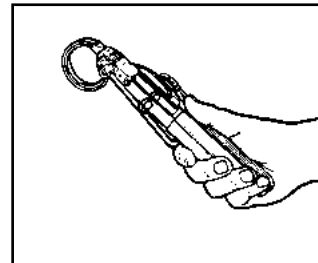

Step 3

Insert tail of band clamp into hand clamping tool.

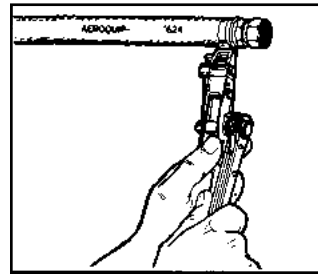

Step 4

Position band clamp over sleeve as shown and then draw tight with hand tool. Remove tool and cut free end of band clamp. Repeat on other end of assembly. To complete, bend protruding tail of clamp over clamp buckle. Also repair any scuffs or minor abrasions of firesleeve by brush application of End Dip AE13702-003.

Crimp Assembly Equipment

FT1380



The ProCrimp 1380 crimp machine from Eaton crimps all your hose needs up to and including -20 SAE100R12 hose styles and the popular MatchMate Plus hose and fittings program (shown with optional die holder kit FT1380-2-4). The ProCrimp 1380 is electronically controlled to give fast, accurate crimps the first time and every time you need a hose assembly. The electronic keypad is easy to adjust, with up to 10 programmable crimp settings. For hose styles and sizes used less frequently simply enter the 3 digit code of that hose.

Ordering Instructions

- FT1380-115** 115V crimp machine 50/60 Hz
- FT1380-115-5** 2-Wire braid hose package FT1380-115 with the 5 die cages needed to crimp the 5 most popular GH793 or GH781 2-wire hose sizes: -4, -6, -8, -12 and -16
Die Cages
FT1380-200-M150
FT1380-200-M210
FT1380-200-M240
FT1380-200-M320
FT1380-275-M370
- FT1380-115-8** Braided and spiral hose package FT1380-115-5 with the 3 additional die cages — capable of crimping all MatchMate Plus hoses through -20
Die Cages
FT1380-200-M180
FT1380-200-M280
FT1380-275-M465
* Must also order FT1380-275-M420 to crimp GH194-20 and GH663-20
- FT1380-2-3** FT1330 to FT1380 Die Cage conversion kit — back plate, bolts and instructions necessary to convert an FT1330 die cage to an FT1380 die cage. Simply remove the FT1330 back plate and replace it with the new FT1380 back plate.
- FT1380-2-4** Optional die holder kit — Kit includes 4 die holder plates each of which will hold 2 die cages. Holes are pre-drilled on base of ProCrimp machine to accept these 4 plates.
- FT1380-4** Optional fitting backstop-kit includes backstop and $\frac{5}{32}$ " hex wrench. The backstop allows the 1380 to crimp PTFE hose and be utilized for a fitting locator to increase efficiency.

Electrical Requirements

USA: FT1380-115 standard machine uses 115V, 50/60 Hz, 1.5 hp

Brazil: FT1380-1-2 standard machine uses 230V, 50/60 Hz, 1.5 hp

Australia: FT1380-230 standard machine uses 230V, 50/60 Hz, 1.5 hp

Canada: FT1380-115 standard machine. Requires CSA (Canadian Standards Association) approval. The FT1380-115 is CSA approved and is so noted on the nameplate.

ET1280



Eaton is proud to add the ET1280 crimp machine to its line of crimpers. While being one of our most economical crimp machines to date, the new ET1280 machine boasts a broad crimp capability with an ease-of-use that is sure to please hose assemblers. The new ET1280 will handle virtually all hose styles through -20 SAE100R12 hose and fittings. All die cages, crimp diameters and approved hose and fitting combinations are identical

to the popular FT1380 & FT1380P crimp machines.

The ET1280 also comes in two configurations. The adjustable model allows the machine to be oriented to the preferred angle that the operator desires. This adjustable model may be ordered separately or with your choice of three power options, including a high volume hand pump, a turbo air/hydraulic power unit or a 12-volt DC power unit. The upright model comes standard with a work light and a 110-volt, 50/60 Hz, 1.5 HP electric power unit.

Ordering Instructions Crimp Machine Part Numbers

- ET1280-001** No pump, no tooling
- ET1280-002** 2-Stage hand pump, no tooling
- ET1280-003** Turbo air/hydraulic pump, no tooling
- ET1280-004** 12 VDC pump, no tooling
- ET1280-005** 110 volt, 1-1/2 HP electric pump, no tooling (upright model)

Crimp Machine Package Part Numbers

- ET1280-006** No pump, 8 Die Cages
- ET1280-007** 2-Stage hand pump, 8 Die Cages
- ET1280-008** Turgo air/hydraulic pump, 8 Die Cages
- ET1280-009** 12 VDC pump, 8 Die Cages
- ET1280-010** 110 volt, 1-1/2 HP electric pump, 8 Die Cages (upright model)
- ET1280-011** No pump, 5 Die Cages
- ET1280-012** 2-Stage hand pump, 5 Die Cages
- ET1280-013** Turbo air/hydraulic pump, 5 Die Cages
- ET1280-014** 12 VDC pump, 5 Die Cages
- ET1280-015** 110 volt, 1-1/2 HP electric pump, 5 Die Cages (upright model)

5 Die Cages

- FT1380-200-M150
FT1380-200-M210
FT1380-200-M240
FT1380-200-M320
FT1380-275-M370

8 Die Cages

- Includes the 5 Die Cages plus:
FT1380-200-M180
FT1380-200-M280
FT1380-275-M465

ET1000 Portable, Light Duty, Positive Stop Crimp Machine

Eaton is proud to add the ET1000 crimp machine to its line of portable crimpers. While being our most economical crimp machine to-date, the new ET1000 machine boasts a broad crimp capability with an ease-of-use that is sure to please hose assemblers.

This new crimp machine has been approved to crimp:

- All 1-wire and 2-wire braided MatchMate Plus hoses in sizes 1/4" through 1 1/4" using MatchMate Plus TTC fittings.
- All 4-wire spiral MatchMate Plus hoses in sizes 3/8" through 1", using MatchMate Plus TTC12 fittings.

The new ET1000 crimp machine builds on the success of the prior FT1370 portable crimp machine by using the same basic frame and construction design, but employs a 2-piece split half collet assembly in lieu of the traditional ProCrimp die cages. The correct hose assembly crimp diameter is obtained by the use of a spacer ring that controls the stroke length of the cylinder during the crimping operation.

This new crimp machine may be ordered separately or with one of four power supplies: hand-pump, air/hydraulic pump, 12-volt DC power unit, or a 110-volt AC power unit.

Features

- Pusher slides out of position.
- Compatible with the Aeroquip MatchMate Plus hose and fittings.
- Can be mounted on service vehicles due to its portable design.
- Can be powered with virtually any 10,000 psi hydraulic power source (min. 36 cubic inch pump reservoir capacity).
- Utilizes 2-piece collet assemblies.
- Spacer rings control the crimp diameter.

Benefits

- Sliding pusher allows for easier fitting insertion into the machine.
- Simple positive-stop crimp diameter control system for consistent crimping time after time with no operator adjustments required.
- Easily transported between job sites.
- Versatile power source options.
- Electricity is required only when using an electric style pump.



Specifications

Dimensions-22 inches high, 16 inches wide, 14 inches in depth

Weight 70 lbs. (without pump)

ET1000 Crimp Machine Part Numbers

For tooling and crimping information, refer to the Collet/Spacer Ring Selector Chart, A-EQCR-MG001-E.

All part numbers include the basic crimp machine.

ET1000-001 = No pump, no tooling (basic machine only)

ET1000-002 = Hand-pump, no tooling

ET1000-003 = Air/hydraulic pump, no tooling

ET1000-004 = 110 volt 1/2HP electric pump, no tooling

ET1000-005 = 12 V DC pump, no tooling

ET1000 Crimp Machine Package Part Numbers

These machine packaged part numbers offer a variety of pumps with the same tooling package including all collets and spacer rings to crimp:

1-wire and 2-wire braided MatchMate Plus Hoses (sizes 1/4" through 1 1/4") using TTC fittings

GH493, 4-wire spiral MatchMate Plus Hose (sizes 3/8" through 1") using TTC12 fittings

ET1000-006 = No pump, but includes complete MatchMate Plus Collet and Spacer Ring Tooling package described above

ET1000-007 = Air/hydraulic pump, and complete MatchMate Plus Collet and Spacer Ring Tooling package described above

ET1000-008 = 110 Volt electric pump, and complete MatchMate Plus Collet and Spacer Ring Tooling package described above

ET1000-009 = 2-Stage hand pump, and complete MatchMate Plus Collet and Spacer Ring Tooling package described above

ET1000-010 = 12 Volt DC pump, and complete MatchMate Plus Collet and Spacer Ring Tooling package described above

ProCrimp® 1390



Crimped hose assembly machine

Hose Specifications

All styles from 3/16" through 2" I.D. including four and six spiral wire requiring internal skive crimp style fittings.

Features

- Front-end loading design
- Electronic key pad control of crimp diameter
- Power return stroke, return limit control
- Drop-in tooling (crimp die cages)
- Backstop fitting locator
- Width 29", Depth 28", Height 49", Weight 825 lbs.
- Worklamp

Ordering Instructions

FT1390-115 Aeroquip crimp machine, 115V, single phase, 60 Hz, 1 hp motor

FT1390-115-12 Kit includes FT1390-115 machine plus the die cages to crimp -4 through -32 MatchMate Plus fittings.

FT1092 NEVER-SEEZ lubricant

Electrical Requirements

Standard

115V, single phase, 60 Hz, 1 hp.

Optional 230 Volt Machines

FT1390-23050 230V, single phase, 50 Hz crimp machine

FT1390-23050-12 FT1390-23050 with 12 die cages.

FT1390-23060 230V, single phase, 60 Hz crimp machine

FT1390-23060-12 FT1390-23060 with 12 die cages.

Crimp Die Cages

Eaton crimp die cages provide simple "drop-in" tooling for the FT1390 crimp machine. See Crimp Die Cage Applications chart or contact Eaton. Refer to website for current crimp specifications.

Crimp Die Cage Storage Cabinet

Eaton recommends crimp die cages be kept free of dust or dirt. As an option, a cabinet is offered which has the capability of storing nine crimp die cages. Order by part number FT1283.

MatchMate Plus fitting locators

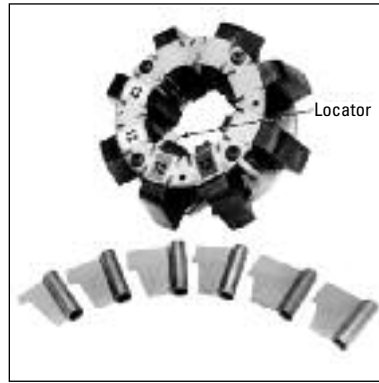

For use with FT1380 and FT1330 "M" Series die cages

Consistent crimping of MatchMate Plus fittings is greatly simplified when using new fitting locators. The locators are designed for easy installation and use on the Eaton FT1380 or FT1330 "M" series die cages noted below.

Ordering Instructions

The locator kits can be ordered as part number FT1330-XL. Each kit contains locators to accommodate -4, -6, -8, -10, -12 and -16 MatchMate Plus fittings and installation instructions.

Locator Suffix	Die Cage Suffix	MatchMate Plus Hoses			
		GH663, GH194	GH793, GH195	GH781	GH493
-4, -4P	-M150	-4	-4	-4	
-6, -6P	-M180	-6			
	-M210		-6	-6	-6
-8, -8P	-M240	-8	-8	-8	
-10, -10P	-M280		-10	-10	-8
-12, -12P	-M320	-12	-12	-12	-12
-16	-M370	-16	-16	-16	-16
None required	-M465		-20	-20	-20

SPECIALTY & TRUCK HOSE

LOW & MEDIUM PRESSURE HOSE

HIGH PRESSURE HOSE

HOSE FITTINGS

ADAPTERS & TUBE FITTINGS

ACCESSORIES & ASSEMBLY INSTRUCTIONS

HOSE ASSEMBLY EQUIPMENT

APPENDICES

Crimp Cages for FT1380

M-Series Crimp Die Cage Applications

Die Cage Part Number	Crimp Range	
	mm	in
FT1380-275-M070	7,0 to 9,0	0.28 to 0.35
FT1380-275-M090	9,0 to 12,0	0.35 to 0.47
FT1380-275-M120	12,0 to 15,0	0.47 to 0.59
FT1380-200-M150*†	15,0 to 18,0	0.59 to 0.71
FT1380-200-M180*†	18,0 to 21,0	0.71 to 0.83
FT1380-200-M210*†	21,0 to 24,0	0.83 to 0.95
FT1380-200-M240*†	24,0 to 28,0	0.95 to 1.10
FT1380-200-M280*†	28,0 to 32,0	1.10 to 1.26
FT1380-200-M320*†	32,0 to 37,0	1.26 to 1.46
FT1380-275-M370*	37,0 to 42,0	1.46 to 1.66
FT1380-275-M420	42,0 to 46,5	1.66 to 1.83
FT1380-275-M465*	46,5 to 52,0	1.83 to 2.05

†:Can be ordered as FT1380-275-SIZE for tool steel dies vs. powdered metal dies.

*FT1380-115-8 kit includes these 8 die cages.

NOTE: Additional dies and die cage assemblies also available.

Refer to website or contact Eaton.

Hose Styles

- Smooth Bore PTFE
- SAE100R1AT
- SAE100R2AT
- HI-PAC
- SAE100R6
- SAE100R8
- SAE100R17
- Convoluted PTFE
- SAE100R1
- SAE100R2A
- SAE100R4
- SAE100R7
- SAE100R12
- Polyon

For crimp specifications on Global Skive type fittings and Global TTC & TTC12 refer to website or contact Eaton for specialty hoses.

Barrel Crimp Die Cage Applications

Die Cage Part Number	Hose Size	Hose Styles
FT1380-275-R5-04	-04	SAE100R5
FT1380-275-R5-05	-05	
FT1380-275-R5-06	-06	
FT1380-275-R5-08	-08	
FT1380-275-R5-10	-10	
FT1380-275-R5-12	-12	
FT1380-275-R5-16	-16	
FT1380-275-R5-20	-20	

Die Cage Repair Kit Complete kit, less dies.

To Repair	Order
FT1380-200-size	FT1380-2-9
FT1380-275-size	FT1380-2-9
FT1380-201-size	FT1380-2-9A

Tooling Compatability Chart

Crimp Machines

	FT1008	FT1049	FT1204	FT1208	FT1209	FT1244	FT1307	FT1310	FT1320	FT1330	FT1340	FT1360	FT1370	FT1380	FT1380P	FT1390	ET1000
FT1008-100-Size	X																
FT1049-100-Size		X															
FT1204-100-Size			X		X ¹	X	X ¹				X ¹	X ¹				X ¹	
FT1208-100-Size				X													
FT1209-200-Size					X		X				X	X				X	
FT1307-200-Size					X		X				X	X				X	
FT1310-200-Size								X									
FT1330-200-Size									X	X							
FT1330-275-Size									X	X							
FT1380-200-Size													X	X	X		
FT1380-201-Size													X	X	X		
FT1380-275-Size													X	X	X		
FT1390-200-Size					X		X				X	X				X	
ET1000-Size																	X

¹ Individual dies. Requires the use of die cage kit FT1307-2-9 or removable die cage FT1307-2-13.

Crimp Cages for FT1390

FT1307-200-Size, FT1209-200-Size & FT1390-200-Size die cages can be used in the FT1390 crimp machine.

Die Cage Part Number	Crimp Range	
	mm	in
FT1307-200-M070	7,0 to 9,0	0.28 to 0.35
FT1307-200-M090	9,0 to 12,0	0.35 to 0.47
FT1307-200-M120	12,0 to 15,0	0.47 to 0.59
FT1307-200-M150*	15,0 to 18,0	0.59 to 0.71
FT1307-200-M180*	18,0 to 21,0	0.71 to 0.83
FT1307-200-M210*	21,0 to 24,0	0.83 to 0.95
FT1307-200-M240*	24,0 to 28,0	0.95 to 1.10
FT1307-200-M280*	28,0 to 32,0	1.10 to 1.26
FT1307-200-M320*	32,0 to 37,0	1.26 to 1.46
FT1307-200-M370*	37,0 to 42,0	1.46 to 1.66
FT1307-200-M420*	42,0 to 46,5	1.66 to 1.83
FT1307-200-M465*	46,5 to 52,0	1.83 to 2.05
FT1307-200-M520*	52,0 to 55,0	2.05 to 2.17
FT1307-200-M550*	55,0 to 69,0	2.17 to 2.71
FT1307-200-M690*	69,0 to 73,0	2.72 to 2.87

*FT1390-115-12 kit includes these 12 die cages.

NOTE: Additional dies and die cage assemblies also available. Refer to website or contact Eaton.

NOTE: FT1209-200-Size & FT1390-200-Size are for use with internal skive and Global Spiral TTC fittings (SAE100R11 & SAE100R13 hose styles).

NOTE: FT1390-200-Size dies cages are hinged to allow ease of use when crimping large elbows.

NOTE: All dies are machined from tool steel.

Hose Styles

- Smooth Bore PTFE
- Polyon
- SAE100R1
- SAE100R2A
- SAE100R4
- SAE100R7
- SAE100R12
- Convoluted PTFE
- SAE100R1AT
- SAE100R2AT
- HI-PAC
- SAE100R6
- SAE100R8
- SAE100R17

For crimp specifications on Global Skive type fittings and Global TTC & TTC12 refer to website or contact Eaton for specialty hoses.

Barrel Crimp Die Cage Applications

Die Cage Part Number	Hose Size	Hose Styles
FT1307-200-R5-04	-04	SAE100R5
FT1307-200-R5-05	-05	
FT1307-200-R5-06	-06	
FT1307-200-R5-08	-08	
FT1307-200-R5-10	-10	
FT1307-200-R5-12	-12	
FT1307-200-R5-16	-16	
FT1307-200-R5-20	-20	
FT1307-200-R5-24	-24	
FT1307-200-R5-32	-32	

Die Cage Repair Kit Complete kit, less dies.

To Repair	Order
FT1307-200-size	FT1307-2-9
FT1390-200-size	FT1390-2-9
FT1209-200-size	FT1209-2-9

Crimp Collets and Spacers for ET1000

Collet Part Numbers	Spacer Ring Part Numbers
ET1000DC-M150S	ET1000SR-M115D (Yellow)
ET1000DC-M195S	ET1000SR-M265D (Black)
ET1000DC-M230S	ET1000SR-M395D (Silver)
ET1000DC-M250S	ET1000SR-M190D (Lt. Green)
ET1000DC-M295S	T-400-37 (Green)
ET1000DC-M320S	T-400-38 (Red)
ET1000DC-M390S	ET1000SR-M100A (Purple)
ET1000DC-M430S	ET1000SR-M315A (Orange)
ET1000DC-M475S	T-400-112 (Tan)

Accessory Part Numbers
1.5 oz. tube of high efficiency PTFE grease = 140-06701

Die Ring Adapter - For Smaller Collets
ET1000AR-001

Reusable Assembly Equipment

FT1097

Portable reusable hose assembly machine

Fitting Specifications

- Any screw together reusable hose fitting with a hex size $2\frac{1}{8}$ " or smaller

Features

- Bench or stand mounted
- Easy to operate
- Convenient foot switch
- U.L. listed
- 102 RPM

Ordering Instructions

Machine:

- FT1097-1-1** Base machine, 110V
- FT1097-1-2** Base machine, 220V
- FT1013-2-2** Machine stand
- FT1220-10** Optional assembly tool kit (see page 317)
- FT1097-2-1** Optional vise kit (see below)

Electrical Requirements

1/2 hp reversible, variable speed, universal motor; as the torque increases the speed decreases. 110V AC, single phase, 25-60 Hz, or 220V, AC, single phase, 25-60 Hz.



FT1097-2-1

Vise kit for FT1097 machine



The optional vise kit for the FT1097 reusable hose assembly machine includes all hardware necessary to install the kit. Reusable hose fitting sockets are conveniently held secure during assembly.

FT1013 Portable reusable hose assembly machine

Fitting Specifications

- Fabric and single wire braid, -04 through -40
- Double wire and 4-spiral wire, -04 through -32



Features

- Quick acting wrench type chuck
- Easy to operate
- Safety guard
- Versatile
- Safety snap type switch
- Safety footswitch
- 36 rpm
- 45" x 56" x 46", 170 lbs.

Ordering Instructions

FT1013-1-5	Base machine, 110V, with vise
FT1013-1-6	Base machine, 220V, with vise
FT1013-1-3	Base machine, 110V, with stand, vise and socketing tool
FT1013-1-4	Base machine, 220V, with stand, vise and socketing tool
FT1013-1-1	Base machine, 110V, with tool kit, stand, vise and socketing tool
FT1013-1-2	Base machine, 220V, with tool kit, stand, vise and socketing tool
FT1013-2-1	Vise
FT1013-2-2	Stand
1562	Tool kit
FT1281	Socketing tool (see below)

Electrical Requirements

1/2 hp reversible, variable speed, universal motor; as the torque increases the speed decreases. 110V AC, single phase, 25-60 Hz, or 220V AC, single phase, 25-60 Hz.

FT1281 Socketing tool



For use with stand mounted FT1013 and FT1097 Portable Hose Assembly Machine. (The FT1281 socketing tool must be accompanied by the FT1097-2-1 vise kit (see page 381) when used on the FT1097 portable hose assembly machine.)

FT1028 Production reusable hose assembly machine

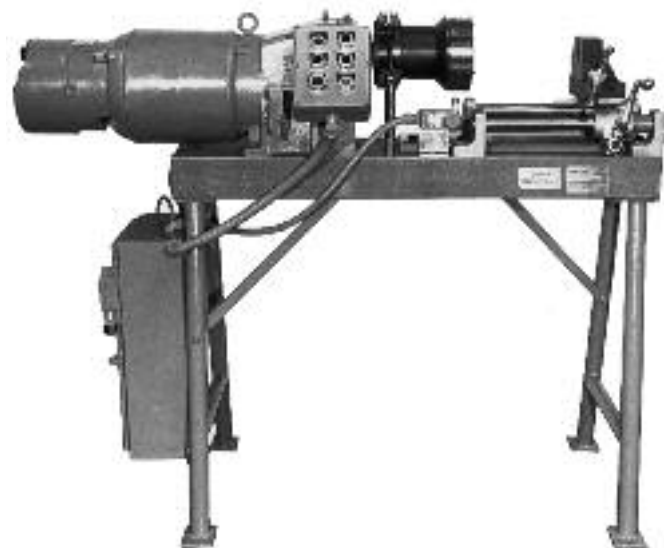

Fitting Specifications

- Screw together fittings—Fabric or wire braided hose up to -32
- Screw together fittings—4 spiral wire hose up to -24

Features

- High volume production
- Ideal for 2 or 3 piece fittings
- 4 speed transmission; 90 rpm, 120 rpm, 210 rpm, 400 rpm
- Easy to operate
- Micrometer stop
- Electric brake
- U.L. listed
- 24" x 62" x 32", 550 lbs.

Electrical Requirements: 220/440V, 3 phase, 60 Hz.

Ordering Instructions

FT1028-1-5 Base machine with automatic stop and spindle control

FT1234 Drop-in socket holder



The FT1234 drop-in socket holder is designed for the FT1028 assembly machine. They prevent rotation of the socket during assembly and provide a back stop to ensure consistent location of the socket.

Part No. FT1234	Hex Size (in.)	Hose Style	Socket Part Number and Size
-100	9/16	2807-4	1206-4
-101	5/8	2807-5, 1503-4, FC300-04 FC350-04, FC321-04	1206-5, 1210-4
-102	11/16	2807-6, 1503-5, FC300-5, FC350-5, FC321-05	1206-6, 1210-5
-104	13/16	1503-6, 1509-4, FC300-6, FC350-6, FC321-06	1210-6, 4010-4
-105	7/8	2807-8	1206-8
-106	15/16	1503-8, FC300-08, FC350-08, FC321-08	1210-8
-200	1	2807-10	1206-10, FC3214-10
-201	1	1509-6, 1508-6	4007-6, 4010-6, 4013-6
-202	1 1/8	1503-10, 1509-8, 1508-8, FC300-10, FC350-10, FC321-10	4013-8
-203	1 1/8	2807-12	1206-12
-204	1 1/4	1503-12, 1509-10, FC300-12, FC350-12	1210-12, 4010-10
-205	1 3/8	2807-16	1212-16, FC3214-16
-206	1 7/16	1503-16, FC300-16, FC350-16, FC321-16	1212-16
-207	1 1/2	1508-12	4007-12, 4013-12
-208	1 5/8		FC3214-20
-209	1 3/4	1503-20, FC300-20,	1212-20 FC350-20

FT1033 Assembly mandrels

The FT1033 assembly mandrels are exclusively designed for use with the FT1028 assembly machine. Secured in the chuck they speed the volume production of Eaton Aeroquip three piece reusable hose fittings.

Part Number	Fitting Number	Part Number	Fitting Number
FT1033-1	FC9215-0404	FT1033-23	401-6
FT1033-2	FC9215-0504	FT1033-24	411-6
FT1033-3	FC9215-0808	FT1033-25	411-8 401-8
FT1033-4	FC9215-0506	FT1033-26	411-10 401-10
FT1033-5	FC9215-1010	FT1033-27	401-12
FT1033-6	FC9210-0606	FT1033-28	411-12
FT1033-7	FC9210-1212	FT1033-29	406-16
FT1033-8	FC9211-0606	FT1033-30	411-16
FT1033-9	FC9211-1212	FT1033-31	406-20
FT1033-10	FC9211-1616	FT1033-32	411-20
FT1033-11	FC9211-2020	FT1033-33	406-24
FT1033-13	FC9212-0204 FC9212-0404 FC9216-0404	FT1033-34	411-24
FT1033-14	FC9212-0406 FC9212-0606	FT1033-35	406-32
FT1033-15	FC9212-0608 FC9212-0808	FT1033-36	411-32
FT1033-16	FC9212-0810	FT1033-37	412-2-4 412-4-4
FT1033-17	FC9212-1212	FT1033-38	412-4-5
FT1033-18	FC9212-1616	FT1033-39	412-4-6
FT1033-19	FC9212-2020	FT1033-40	412-6-12
FT1033-21	411-4 401-4	FT1033-41	412-8-10 412-12-10
FT1033-22	411-5 401-5	FT1033-42	412-12-12

FT1271 Split flange assembly tooling

Specifications

The Eaton designed FT1271 split flange tooling is specifically designed for the FT1028 assembly machine. This tooling makes it easier to secure split flange hose fitting nipples in the chuck of the assembly machine.



FT1095 Elbow reusable fitting holders

Specifications

The optional FT1095 elbow fitting holders will allow the operator to make double elbow hose assemblies on the FT1097 assembly machine and can be used with the FT1028 machine.

Ordering Instructions

Part Number	Nipple Hex Size	For Use With Nipples Marked	Adapter Required For FT1028 Machine
FT1095-100-1	3/8	MP-4	FT1095-101
FT1095-100-2	7/16	MP-5	
FT1095-100-3	1/2	MP-6, HP-4	
FT1095-100-4	5/8	MP-8, HP-6	
FT1095-150-1	11/16	HP-8	FT1095-151
FT1095-150-2	3/4	MP-10	
FT1095-150-3	7/8	MP-12	
FT1095-150-4	15/16	HP-12	
FT1095-150-5	1 1/8	MP-16	
FT1095-150-6	1 1/4	HP-16	
FT1095-150-7	1 3/16	HP-10	
FT1095-200-1	1 3/8	MP-20	FT1095-201
FT1095-200-2	1 5/8	HP-20	

FT1220-10 Reusable fitting assembly mandrels



Specifications

The FT1220-10 kit includes all assembly mandrels listed for -4 through -20 for the assembly of Eaton 411, 401, and 406 reusable hose fittings. Individual mandrels may also be ordered by using the part numbers to the right.

Thread type	SAE 37° (JIC)	SAE 45° PTT	30°
Use with fitting Nos.	411	401	406
Dash size			
-4	1582-4S	1582-4S	
-5	1582-5S	1582-5S	
-6	583-6S	1582-6S	
-8	1582-8S	1582-8S	
-10	1582-10S	1582-10S	
-12	583-12S	1582-12S	
-16	1563-16S		1561-16S
-20	1563-20S		1561-20S
-24	1563-24S		1561-24S
-32	1563-32S		

Kit Part Number	Fitting Part Number	Thread Types	Size Range
1562 (not shown)	401, 406, 411, 412	SAE 45°, SAE 37° (JIC), PTT, NPTF	-4 thru -32
1597 (not shown)	401, 412	SAE 45°, NPTF	-4 thru -12
1598 (not shown)	411, 412	SAE 37° (JIC), NPTF	-4 thru -32
1599 (not shown)	411, 412	SAE 37° (JIC), NPTF	-4 thru -12
FT1220-10	401, 406, 411, 412	SAE 45°, SAE 37° (JIC), PTT, NPTF	-4 thru -20

F2015 SOCKETLESS fitting bench mounted assembly machine



Hose Specifications

- SOCKETLESS hose, all sizes

Features

- Fast, hand assembly
- Bench mounted
- Hose is securely held
- Mandrels included

Ordering Instructions

F2015 Complete machine

FT1081 PTFE hose assembly tool kit



Hose Specifications

Smooth Bore PTFE Hose, -03, -04, -05, -06, -08, -10 and -12 hose. FT1090-3-10-4 and FT1090-3-10-5 are useful wire flare tools to use in conjunction with kit FT1081.

Features

- Inexpensive
- Easy to use
- Seats PTFE tube against sleeve

Ordering Instructions

FT1081 Complete tool kit

Includes:

- FT1081-3-1** mandrel holder
- FT1081-3-2-3** mandrel -3 hose
- FT1081-3-2-4** mandrel -4 hose
- FT1081-3-3-5** mandrel -5 hose
- FT1081-3-4-6** mandrel -6 hose
- FT1081-3-5-8** mandrel -8 hose
- FT1081-3-6-10** mandrel -10 hose
- FT1081-3-7-12** mandrel -12 hose
- FT1081-16** mandrel -16 hose
- FT1081-20** mandrel -20 hose

FT1038A PTFE hose tool



Hose Specifications

- Smooth bore PTFE Hose, -03, -04, -05, -06, -08, -10 and -12

Features

- Small
- Hand held tool

Ordering Instructions

- FT1038A** PTFE Hose Tool (-03 thru -12)
- FT1038B** PTFE Hose Tool (-16, -20)

Hose Cut Off Equipment

FT1258 Cut off tool



Specifications

FT1258 bench mounted cut off tool. A bench mounted cutter for in-plant production of Polyon hose assemblies and other fabric reinforced hose styles.

Ordering Instructions

FT1258 Cut-off tool

FT1258-2-2 Blade kit

Package of three replacement blades for FT1258 tool which are designed to cut all fabric reinforced hose including Kevlar.*

**Kevlar is a trademark of E.I. DuPont.*

SPECIALTY &
TRUCK HOSE

LOW & MEDIUM
PRESSURE HOSE

HIGH PRESSURE HOSE

FT1500 Machine



Features:

- Powerful 4.2-hp high torque motor for faster and easier cutting
- Clear face shield guard for added safety
- Includes mounting hardware and protective goggles

- Standard 14" scalloped blade:
 - Cuts 1- and 2-wire braided hose through 2" I.D.
 - Cuts 4-wire spiral hose through 2" I.D.
 - Cuts 6-wire spiral hose through 1-1/2" I.D.
 - Lasts longer by dissipating heat/reducing friction
 - Blade can be reversed for added blade life
 - New blade sharpening service agreement

Ordering Instructions

Machine:

FT1500 Includes machine with 14" scalloped blade

Optional Cutting Blades:

- **FT1500-1** Scalloped blade is standard
- **FT1500-2** Smooth beveled blade cuts Stainless Steel braided cover hose.
- **FT1500-4** Scalloped toothed blade cuts Industrial Fluid Transfer hoses through 4" I.D.

HOSE FITTINGS

ADAPTERS &
TUBE FITTINGS

ACCESSORIES &
ASSEMBLY INSTRUCTIONS

HOSE ASSEMBLY
EQUIPMENT

APPENDICES

S1104
Hose cut off machine

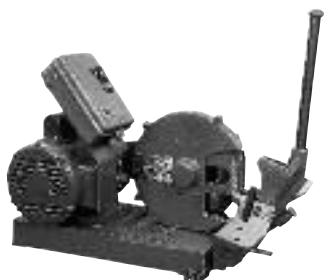

Hose Specifications

- Single and Double Wire Reinforced, 1/4" to 3" I.D.
- Four and Six Spiral Wire Reinforced, 1/4" to 1 1/2" I.D. with optional blades FT1101-1 and FT1101-2, spiral wire capacity is increased to 2"

Features

- Compact, 22" x 24"
- Light, 130 lbs.
- Dual V-belt drive
- 10" cutting blade
- U.L. listed

**A 3 hp, 230V AC, single phase machine is also available but not recommended because of reduced torque and less capability when cutting larger size hose. Order by part number S1104-230.*

Electrical Requirements

3 hp, 230/460V, 3 phase, 60 Hz.
 Machine wired for 230V AC. Change connections as shown on motor plate for 460V. Also, replace 230V motor heater with 460V motor heater included with machine.

Ordering Instructions

- Machine:
- S1104** Basic machine, 230/460V, 3 phase, 60 Hz
 - S1026** Hose measuring gauge attachment
 - FT1215** Hose reel attachment
 - S1118** Coolant spray system (required when cutting spiral wire hose)
 - SC1709** 10" Replacement cutting blade
 - SC1772** Welded steel table

Optional Cutting Blades

FT1101-1

10" Scalloped Blade



FT1101-2

10" Abrasive Blade



FT1260
Hose cut off machine



Hose Specifications

- All Hose Constructions – 1/4" to 4" I.D.

Features

- Built in safety features
- Easy to operate
- 16" abrasive wheel
- Heavy duty design
- Low maintenance
- V shaped vise
- U.L. listed

Ordering Instructions

- Machine:
- FT1260-1-1** Base machine with stand. 230/460V, 3 phase, 60 Hz
 - FT1260-1-2** Base machine with stand and fume exhauster. 230/460V, 3 phase 60 Hz
 - FT1260-1-3** Base machine with stand. 230V, single phase, 60 Hz
 - FT1260-1-4** Base machine with stand and fume exhauster. 230V, single phase, 60 Hz
 - FT1260-2-5** Optional hood (can be used only with the -1-2 and the -1-4 models) Eaton recommends the use of FT1260-2-5, optional hood.

Replacement Components:

- FT1260-3-1** Replacement 16" fiberglass reinforced abrasive wheel

Electrical Requirements

Electrical requirements will vary depending on options selected.
 Contact Eaton for additional information.

SPECIALTY & TRUCK HOSE
 LOW & MEDIUM PRESSURE HOSE
 HIGH PRESSURE HOSE
 HOSE FITTINGS
 ADAPTERS & TUBE FITTINGS
 ACCESSORIES & ASSEMBLY INSTRUCTIONS
 HOSE ASSEMBLY EQUIPMENT
 APPENDICES

**S1120
Hose preparation package**



SPECIALTY &
TRUCK HOSE

LOW & MEDIUM
PRESSURE HOSE

HIGH PRESSURE HOSE

HOSE FITTINGS

ADAPTERS &
TUBE FITTINGS

ACCESSORIES &
ASSEMBLY INSTRUCTIONS

HOSE ASSEMBLY
EQUIPMENT

APPENDICES

Hose Specifications

Cutting 3/16" to 3"
Skiving 1/4" to 2"

Features

- Fast, efficient hose cutting
- 10" cutting blade
- Easily adjusted, self-contained skiving mandrels for reusable fittings
- Safe collection of skived rubber
- Spray system prolongs blade life
- Rotary hose reel for easy hose handling
- 24" x 42" x 24", 240 lbs.
- Double V belt cutting drive
- Direct skiving drive

Electrical Requirements

3 hp (in S1102 machine saw), 1/3 hp (in dust collector), 230/460V AC, 60 Hz, 3 phase

Blade Selection

Eaton offers three different cutting blades to make cutting of wire braid and spiral wire hose quick and easy.

Ordering Instructions

The S1120 hose preparation package may be ordered as a complete assembly or the five different components of the package may be ordered individually.

S1120* Hose Preparation Package

S1102* Includes: Basic Cut Off and Skiving Machine

S1043* Collector and Table

S1026 Hose Measuring Gauge Attachment

FT1215 Hose Reel Attachment

S1118 Coolant Spray System

SC1681 (Optional) Replacement Skiving Brush

*A 3 hp 230V AC single phase motor is also available but not recommended due to reduced torque and less capability in cutting larger size hose. The following part numbers must be used when ordering components with single phase motors:

S1120-230 Hose Preparation Package

S1102-230 Basic Cut Off and Skiving Machine

S1043-230 Dust Collector and Table



SC1709

Standard replacement cutting blade (one included with each machine).



FT1101-1

Scalloped cutting blade (optional; used for cutting spiral wire hose).



FT1101-2

Abrasive cutting blade (optional; used for cutting spiral wire hose).

Skiving Equipment

Skiving Tools

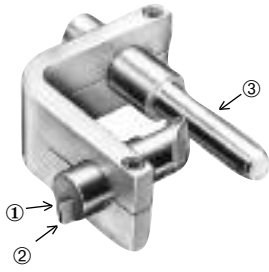

FT1229-Size

Silver Chromate Mandrel
(for reusable fittings)

- ① FT1229-2-3 blade holder
- ② FT1229-3-4 skive blade
- ③ FT1229-100-size



FT1230-Size

Yellow Chromate Mandrel
(for crimp fittings)

- ① FT1229-2-3 blade holder
- ② FT1229-3-4 skive blade
- ③ FT1230-100-size



FT1231-Size

Black Oxide Mandrel
(for internal skive crimp fittings)

For skiving rubber covered wire reinforced hoses

When selecting skive tools, refer to Eaton document A-EQCR-TM001-E for proper skive length of hose sizes.

Hose Size	Reusable Fittings		Crimp Fittings		Crimp Internal Skive Fittings	
	FT1229	Skive Length	FT1230	Skive Length	FT1231	Skive Length
-03			-3	0.45		
-04	-4	0.91	-4	0.76		
-05			-5	0.76		
-06	-6	1.15 1.23 1.30	-6	.90		
-08	-8	1.25	-8	1.04	-8	1.34
-10	-10	1.25	-10	1.11		
-12	-12	1.40	-12 ¹	1.21 1.31	-12	1.40
		-12B ³		2.40		
-16	-16	1.65 2.30	-16	1.30	-16	1.85
		-16B ³		2.30		
-20	-20	2.09	-20 ¹	1.66 1.52 1.88	-20	2.05
		-20A ⁴		2.60		
		-20B ³		2.75		
-24	-24	1.95	-24 ¹	1.74 1.64 2.18	-24	2.05
		-24B ⁵		2.60		
-32	-32 ²	2.05			-32	2.30

¹Adjustable tool.

²FT1229-32 tool is used for reusable and crimp fittings.

³For FC606.

⁴For FC136.

⁵For FC136 and FC254.

FT1240 Internal skive tooling



FT1240-100-Size



FT1240-150-Size

* When tooling begins to wear, contact customer service for information on how to exchange for sharpened tooling.

Internal Skive Tool	FC254	FC323 FC324 FC273	FC325	FC606
FT1240-150-8	-08			
FT1240-100-12		-12	-12	
FT1240-150-12	-12			
FT1240-150-16	-16	-16	-16	-16
FT1240-100-20		-20	-20	
FT1240-150-20	-20			-20
FT1240-100-24		-24	-24	
FT1240-150-24	-24			
FT1240-100-32		-32	-32	
FT1240-150-32	-32			

FT1279 Auger attachment



The FT1279 auger attachment permits efficient skiving of rubber covered wire reinforced hose.

Designed for use with FT1229, FT1230 and FT1231 skiving tools, the FT1279 auger attachment promotes quick completion of hand skiving operations.

Hose Proof Test Stands

FT1312 Hose proof test stand



Hose Specifications

Assembles up to 2" I.D., 6 spiral wire

Features

- Designed to use tap water, eliminating the need for a special test fluid
- Compact power unit is air driven
- Air regulator and gauge provide easy pressure adjustment and monitoring
- Tough transparent Lexan* lid
- 79" x 36" x 53", 550 lbs.

Power Unit

The power unit of the FT1312 tester is a compact, economical air driven hydraulic pump. It will provide sufficient hydraulic pressure to proof test any Aeroquip hose assembly, up to 22,000 psi.

**Lexan is a General Electric trademark.*

FT1261 Hose proof test stand



Hose Specifications

Assembles up to 2" I.D., 6 spiral wire in 50 ft. coil lengths

Features

- Designed to use tap water, eliminating the need for a special test fluid
- Air regulator and gauge provide easy pressure adjustment and monitoring
- Tough transparent Lexan* lid
- 96" x 84" x 54", 800 lbs.

Power Unit

The power unit of the FT1261 tester is a compact, economical air driven hydraulic pump. It will provide sufficient hydraulic pressure to proof test any Aeroquip hose assembly, up to 22,000 psi.

**Lexan is a General Electric trademark.*

FT1312 and FT1261 Standard adapter selection chart

Hose Fitting* Style and Size	Fitting Adapter Part Number	Pressure Port Adapter Part Number	Plug or Cap Part Number
SAE 37° (JIC) Swivel			
-4	2027-8-4S	**	900599-4
-5	2021-6-5S	2081-12-6S	900599-5
-6	2027-8-6S	**	900599-6
-8	2027-8-8S	**	900599-8
-10	2027-10-8S	**	900599-10
-12	2027-8-12S	**	900599-12
-16	2021-12-16S	**	900599-16
-20	2021-16-20S	2040-12-16S	900599-20
-24	2021-16-24S	2040-12-16S	900599-24
-32	2021-16-32S	2040-12-16S	900599-32
SAE 45° Swivel			
-4	2000-6-4B	2081-12-6S	900599-4
-5	2000-6-5B	2081-12-6S	900599-5
-6	2000-6-6B	2081-12-6S	2001-6-6B, 2082-6S
-8	2000-12-8B	**	900599-8
-10	2000-12-10B	**	900599-10
-12	2000-12-12B	**	2001-8-12B, 2082-8S
Male Pipe			
-2	2081-8-2S	2081-12-8S	2046-2-2S, 2082-2S
-4	2081-8-4S	2081-12-8S	2046-4-4S, 2082-4S
-6	2081-8-6S	2081-12-8S	2046-6-6S, 2082-6S
-8	2081-8-8S	**	2046-8-8S, 2082-8S
-12		**	2046-12-12S, 2082-12S
-16	2040-12-16S	**	2046-16-16S, 2082-16S
-20	2040-16-20S	2040-12-16S	2046-20-20S, 2082-20S
-24	2040-20-24S	2040-12-16S, 2040-16-20S	2046-24-24S, 2082-24S
-32	2040-24-32S	2040-12-16S, 2040-16-20S, 2040-20-24S	2046-32-32S, 2082-32S

**Two adapters are required per hose assembly to be tested.*

***Internal Skive Fittings Only.*

SPECIALTY & TRUCK HOSE

LOW & MEDIUM PRESSURE HOSE

HIGH PRESSURE HOSE

HOSE FITTINGS

ADAPTERS & TUBE FITTINGS

ACCESSORIES & ASSEMBLY INSTRUCTIONS

HOSE ASSEMBLY EQUIPMENT

APPENDICES

FT1058 Hose proof test stand



Features

- Pressure gauge
- Release valve
- Hand hydraulic pump
- Foot switch
- Fluid reservoir, use SAE 5 wt. hydraulic oil (oil not included)
- Electric fluid pump
- Safety lid
- Pressure port (3/4-14 NPTF Female Port)
- 42" x 22" x 9" (41" with legs), 75 lbs.
- 10,000 psi maximum proof pressure

Electrical Requirements

110V 60 Hz, single phase motor

Ordering Instructions

FT1058 as shown above. Legs can be removed for bench mounting.

FT1058 Adapter selection chart

Hose Fitting* Style and Size	Fitting Adapter Part Number	Pressure Port Adapter Part Number	Plug or Cap Part Number
SAE 37° (JIC) Swivel			
-4	2021-6-4S	2081-12-6S	900599-4
-5	2021-6-5S	2081-12-6S	900599-5
-6	2021-12-6S		900599-6
-8	2021-12-8S		900599-8
-10	2021-12-10S		900599-10
-12	2021-12-12S		900599-12
-16	2021-12-16S		900599-16
-20	2021-16-20S	2040-12-16S	900599-20
-24	2021-16-24S	2040-12-16S	900599-24
-32	2021-16-32S	2040-12-16S	900599-32
SAE 45° Swivel			
-4	2000-6-4B	2081-12-6S	900599-4
-5	2000-6-5B	2081-12-6S	900599-5
-6	2000-6-6B	2081-12-6S	2001-6-6B, 2082-6S
-8	2000-12-8B		900599-8
-10	2000-12-10B		900599-10
-12	2000-12-12B		2001-8-12B, 2082-8S
Male Pipe			
-2	2081-8-2S	2081-12-8S	2046-1-2S, 2082-2S
-4	2081-8-4S	2081-12-8S	2046-4-4S, 2082-4S
-6	2081-8-6S	2081-12-8S	2046-6-6S, 2082-6S
-8	2081-12-8S		2046-8-8S, 2082-8S
-12			2046-12-12S, 2082-12S
-16	2040-12-16S		2046-16-16S, 2082-16S
-20	2040-16-20S	2040-12-16S	2046-20-20S, 2082-20S
-24	2040-20-24S	2040-12-16S, 2040-16-20S	2046-24-24S, 2082-24S
-32	2040-24-32S	2040-12-16S, 2040-16-20S, 2040-20-24S	2046-32-32S, 2082-32S

*Adapters are available for other hose fitting styles. Contact Eaton.